

JVC

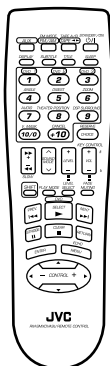

COMPACT COMPONENT SYSTEM

CA-MXDVA9

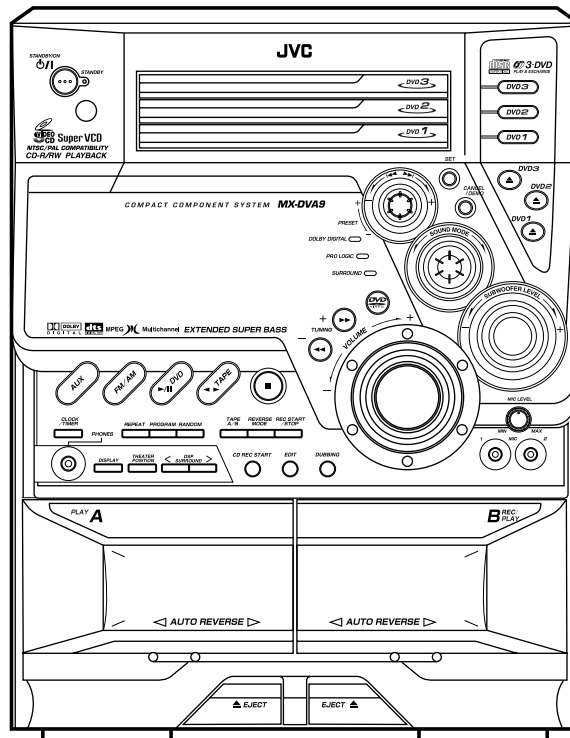

MPEG Multichannel

INSTRUCTIONS

For Customer Use:

Enter below the Model No. and Serial No. which are located either on the rear, bottom or side of the cabinet. Retain this information for future reference.

Model No. _____

Serial No. _____

GVT0057-016A
(UG, UN, US, UW, UX)

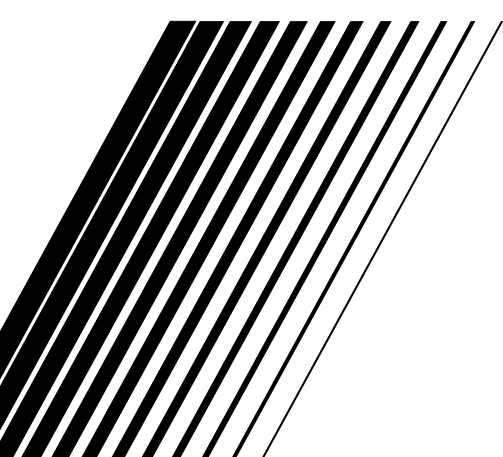

Warnings, Cautions and Others

Caution — STANDBY/ON button!

Disconnect the mains plug to shut the power off completely. The STANDBY/ON  button in any position does not disconnect the mains line. The power can be remote controlled.

CAUTION

To reduce the risk of electrical shocks, fire, etc.:

1. Do not remove screws, covers or cabinet.
2. Do not expose this appliance to rain or moisture.

CAUTION

- Do not block the ventilation openings or holes.
(If the ventilation openings or holes are blocked by a newspaper or cloth, etc., the heat may not be able to get out.)
- Do not place any naked flame sources, such as lighted candles, on the apparatus.
- When discarding batteries, environmental problems must be considered and local rules or laws governing the disposal of these batteries must be followed strictly.
- Do not use this apparatus in a bathroom or places with water. Also do not place any containers filled with water or liquids (such as cosmetics or medicines, flower vases, potted plants, cups, etc.) on top of this apparatus.

IMPORTANT FOR LASER PRODUCTS

REPRODUCTION OF LABELS

① CLASSIFICATION LABEL, PLACED ON REAR ENCLOSURE

② WARNING LABEL, PLACED INSIDE THE UNIT

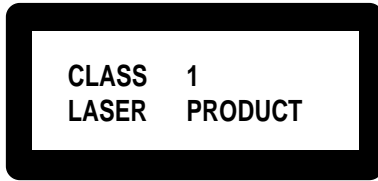

DANGER: Invisible laser radiation when open and interlock failed or defeated. AVOID DIRECT EXPOSURE TO BEAM. (e)

WARNING: Osynlig laserstrålning när denna del är öppnad och spärren är urkopplad. Betrakta ej strålen. (s)

ADVARSEL: Usynlig laserstråling ved åbning, når sikkerhedsafbrydere er ude af funktion. Undgå udsættelse for stråling (d)

VARO: Avattaessa ja suo-
jalukitus ohitettaessa olet
alttiina näkymättömälle
lasersäteilylle. Älä katso
säteeseen. (f)

1. CLASS 1 LASER PRODUCT
2. **DANGER:** Invisible laser radiation when open and interlock failed or defeated. Avoid direct exposure to beam.
3. **CAUTION:** Do not open the top cover. There are no user serviceable parts inside the Unit; leave all servicing to qualified service personnel.

Caution: Proper Ventilation

To avoid risk of electric shock and fire, and to prevent damage, locate the apparatus as follows:

- 1 Front: No obstructions and open spacing.
- 2 Sides/ Top/ Back: No obstructions should be placed in the areas shown by the dimensions below.
- 3 Bottom: Place on the level surface. Maintain an adequate air path for ventilation by placing on a stand with a height of 10 cm or more.

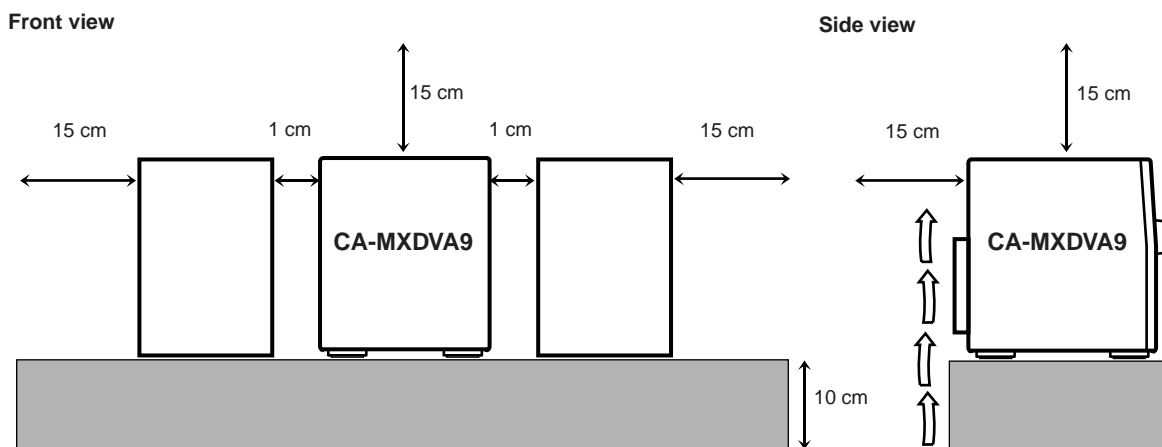

Introduction

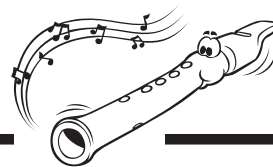

We would like to thank you for purchasing one of our JVC products. Before operating this unit, read this manual carefully and thoroughly to obtain the best possible performance from your unit, and retain this manual for future reference.

About This Manual

This manual is organized as follows:

- **The manual mainly explains operations using the buttons and controls on the unit. You can also use the buttons on the remote control if they have the same or similar names (or marks) as those on the unit. If operation using the remote control is different from that using the unit, it is then explained.**
- Basic and common information that is the same for many functions is grouped in one place, and is not repeated in each procedure. For instance, we do not repeat the information about turning on/off the unit, setting the volume, changing the sound effects, and others, which are explained in the section “Common Operations” on pages 11 to 14.
- The following marks are used in this manual:



Gives you warnings and cautions to prevent from damage or risk of fire/electric shock. Also gives you information which is not good for obtaining the best possible performance from the unit.



Gives you information and hints you had better know.

Precautions

Installation

- Install in a place which is level, dry and neither too hot nor too cold—between 5°C (41°F) and 35°C (95°F).
- Install the unit in a location with adequate ventilation to prevent internal heat buildup in the unit.
- Leave sufficient distance between the unit and the TV.
- Keep the speakers away from the TV to avoid interference with TV.



DO NOT install the unit in a location near heat sources, or in a place subject to direct sunlight, excessive dust or vibration.

Power sources

- When unplugging from the wall outlet, always pull the plug, not the AC power cord.



DO NOT handle the AC power cord with wet hands.

Moisture condensation

Moisture may condense on the lens inside the unit in the following cases:

- After starting heating in the room
- In a damp room
- If the unit is brought directly from a cold to a warm place should this occur, the unit may malfunction. In this case, leave the unit turned on for a few hours until the moisture evaporates, unplug the AC power cord, and then plug it in again.

Others

- Should any metallic object or liquid fall into the unit, unplug the AC power cord and consult your dealer before operating any further.
- If you are not going to operate the unit for an extended period of time, unplug the AC power cord from the wall outlet.



DO NOT disassemble the unit since there are no user serviceable parts inside.

If anything goes wrong, unplug the AC power cord and consult your dealer.

Contents

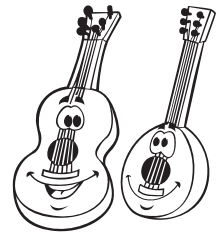

Location of the Buttons and Controls	3	DVD/SVCD/VCD Special Effect Playback	28
Front Panel	3	Still Picture/Frame-by-Frame Playback	28
Remote Control	5	Viewing Continuous Still Pictures—Strobe	28
Getting Started	6	Slow Motion Playback—Slow	28
Supplied Accessories	6	Zoom in the Picture—Zoom	28
Putting the Batteries into the Remote Control	6	Viewing the Desired Chapters/Tracks—Digest	29
Connecting Antennas	6	Selecting the Picture Brightness	
Connecting Speakers	7	—Theater Position	29
Connecting Other Equipment	8	Playing Back Tapes	30
Adjusting the Voltage Selector	10	Playing Back a Tape	30
Canceling the Display Demonstration	10	Locating the Beginning of a Song—Music Scan	30
Common Operations	11	Using DSP Surround Mode	31
Turning On or Off the Power	11	Activating and Adjusting	
Setting the Clock	11	the DSP Surround Mode	31
Setting the AM Tuner Interval Spacing	11	Recording	32
Selecting the Sources	12	Recording a Tape on Deck B	32
Adjusting the Volume	12	Dubbing Tapes	33
Adjusting the Front Speaker Output Balance	12	SVCD/VCD/CD Direct Recording	33
Reinforcing the Bass Sound	13	Auto Edit Recording	34
Selecting the Sound Modes	13	Using the Microphones	35
Creating Your Own Sound Modes		Singing along (Karaoke)	35
—Manual Mode	14	Reserving Karaoke Songs	
Listening to FM and AM Broadcasts	15	—Karaoke Program Play	37
Tuning into a Station	15	Operating the On-Screen Menu	38
Presetting Stations	15	Basic Procedure	38
Tuning into a Preset Station	15	Changing the Initial Language Settings	39
Playing Back Discs—Introduction	16	Changing the Various Audio Settings	39
Disc Structure	17	Changing the Display Settings	41
DVD Features	17	Changing the System Settings	42
Selecting the Multi-Angle View	17	Using the Parental Lock	43
Selecting the Audio Language or Sound	18	Setting the Parental Lock Level	43
Selecting the Subtitle	18	Unlocking the Parental Lock Temporarily	43
Basic Disc Playback	19	Using the Timers	44
Loading Discs	19	Using Daily Timer	44
Common Basic Disc Operations	19	Using Recording Timer	46
DVD Playback	19	Using Sleep Timer	47
SVCD/VCD/CD Playback	21	Timer Priority	47
Searching for a Particular Point	22	Using AV COMPU LINK Control System	48
Prohibiting Disc Ejection—Tray Lock	22	Appendix A—Maintenance	49
Menu Driven Playback	23	Appendix B—Troubleshooting	50
Menu Operations	23	Appendix C—Output Signals Through the	
Selecting Playback Modes	24	OPTICAL DIGITAL OUTPUT Terminal	51
Programming the Playing Order of the Titles and		Appendix D—Channel Display	51
Tracks—Program Play	24	Appendix E—Language Code	
Playing at Random—Random Play	26	for On-Screen Menu	52
Repeating Playback	26	Appendix F—Country Code for Parental Lock	53
• Repeat Play	26	Appendix G—Glossary	55
• A-B Repeat	27	Specifications	56

Location of the Buttons and Controls

Become familiar with the buttons and controls on your unit.

Front Panel

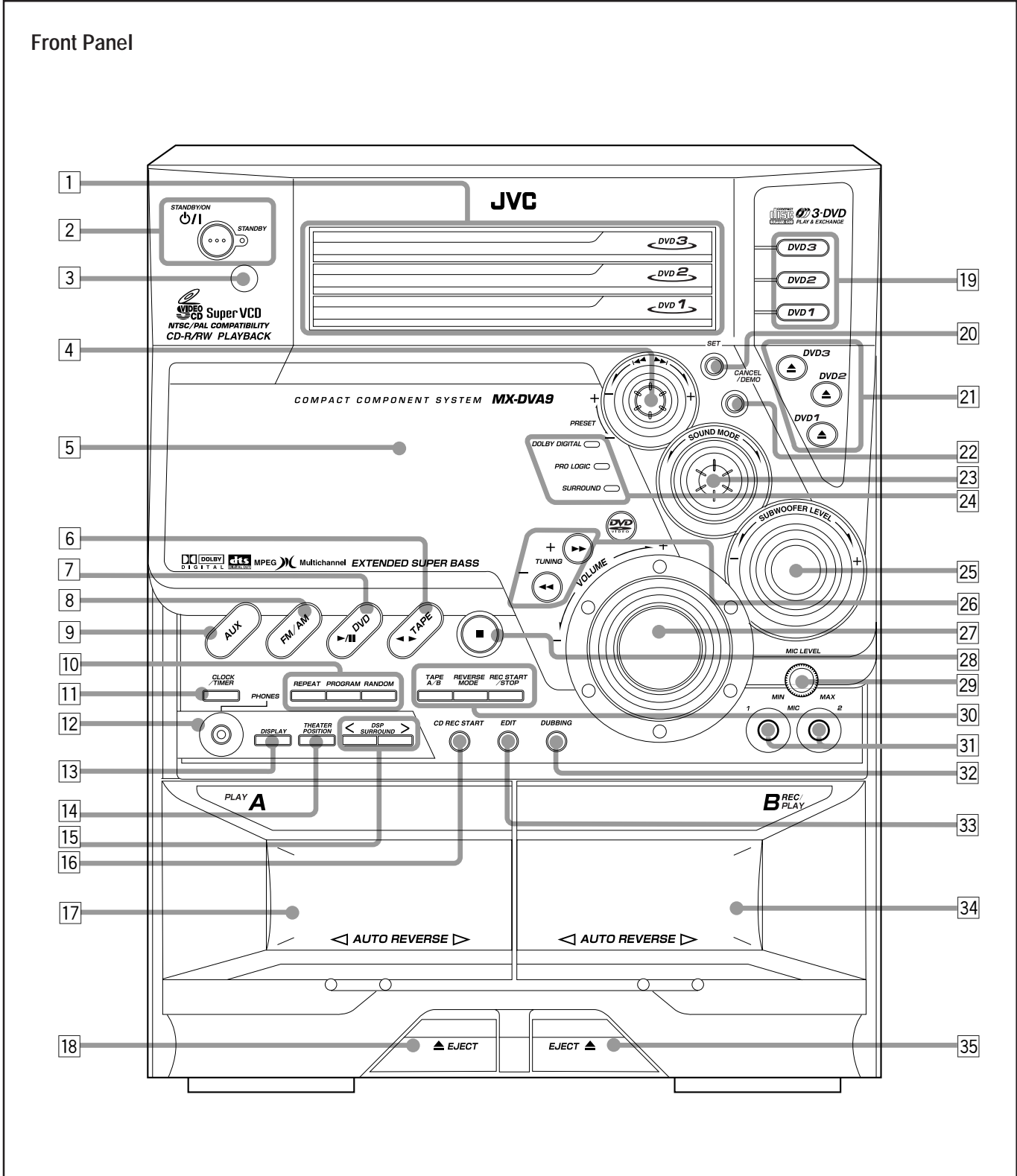

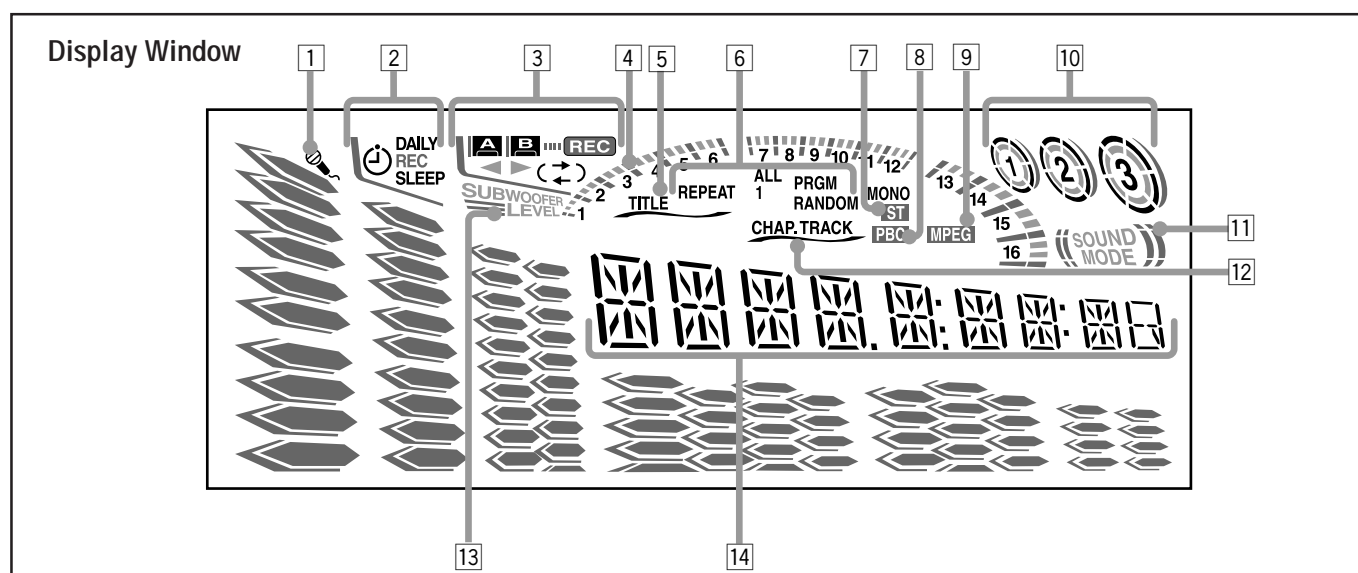

See pages in the parentheses for details.

Front Panel

- 1 Disc trays
- 2 STANDBY/ON O/I button and STANDBY lamp (11, 45, 46)
- 3 Remote sensor
- 4 PRESET + / - control (15)
◀◀ / ▶▶ (reverse search/forward search) control (11, 14, 20, 21, 24, 26, 34, 44 - 46)
- 5 Display window
- 6 TAPE ◀▶ button and lamp (12, 30, 32, 33)
Pressing this button also turns on the unit.
- 7 DVD ▶/|| (play/pause) button and lamp (12, 19 - 24, 26, 36)
Pressing this button also turns on the unit.
- 8 FM/AM button and lamp (12, 15)
Pressing this button also turns on the unit.
- 9 AUX button and lamp (12)
Pressing this button also turns on the unit.
- 10 Disc play mode buttons
 - REPEAT button (23, 27)
 - PROGRAM button (24, 25, 37)
 - RANDOM button (26)
- 11 CLOCK/TIMER button (11, 44 - 47)
- 12 PHONES jack (12, 20, 39)
- 13 DISPLAY button (17, 20, 22, 51)
- 14 THEATER POSITION button (29)
- 15 DSP SURROUND < / > buttons (31)
- 16 CD REC START button (33, 34)
- 17 Deck A cassette holder (30)
- 18 ▲ EJECT button for deck A (30)
- 19 Disc number buttons and lamps (DVD1, DVD2, and DVD3) (19, 21, 24, 26, 33, 34)
Pressing one of these buttons also turns on the unit.
- 20 SET button (10, 11, 14, 15, 24, 34, 44 - 47)
- 21 ▲ (Disc tray open/close) buttons (DVD1, DVD2, and DVD3) (19, 20 - 22)
Pressing one of these buttons also turns on the unit.
- 22 CANCEL/DEMO button (10, 11, 24, 34, 44 - 47)
- 23 SOUND MODE control (13)

- 24 DOLBY DIGITAL lamp (17, 20)
PRO LOGIC lamp (39)
SURROUND lamp (31)
- 25 SUBWOOFER LEVEL + / - control (13)
- 26 TUNING + / - buttons (15)
◀◀ / ▶▶ (fast reverse/fast forward) buttons (14, 22, 30)
- 27 VOLUME + / - control (12, 35)
- 28 ■ (stop) button (11, 20 - 26, 30, 32 - 34, 36, 46)
- 29 MIC LEVEL control (35, 36)
- 30 Tape operation buttons
 - TAPE A/B button (30)
 - REVERSE MODE button (30, 32 - 34)
 - REC START/STOP button (32 - 36, 46)
- 31 MIC 1 and MIC 2 jacks (35, 36)
- 32 DUBBING button (33)
- 33 EDIT button (34)
- 34 Deck B cassette holder (30, 32)
- 35 EJECT ▲ button for deck B (30, 32)

Display Window

- 1 Karaoke (🎤) indicator
- 2 Timer indicators
 - ⌚ (Timer), DAILY (Daily Timer), REC (Recording Timer), and SLEEP (Sleep Timer) indicators
- 3 Tape operation indicators
 - A/B (operating deck), REC (recording), ◀▶ (tape direction), and ⏮ (reverse mode) indicators
- 4 Title and track number (1 - 16) indicators
- 5 TITLE indicator
- 6 Disc play mode indicators
 - REPEAT (ALL/1), PRGM (program), and RANDOM indicators
- 7 Tuner operation indicators
 - MONO and ST (stereo) indicators
- 8 PBC indicator
- 9 MPEG indicator
- 10 Disc indicators
- 11 SOUND MODE indicator
- 12 CHAP. (chapter) and TRACK indicators
- 13 SUBWOOFER LEVEL indicator
- 14 Main display
 - Shows the source name, frequency, etc.



Remote Control

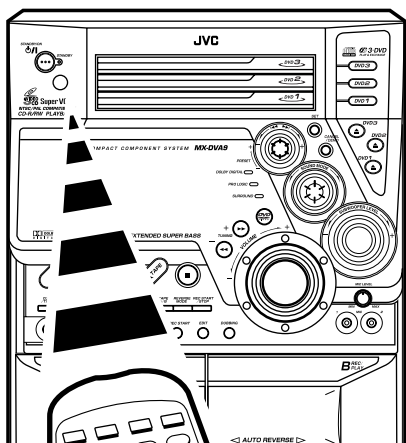
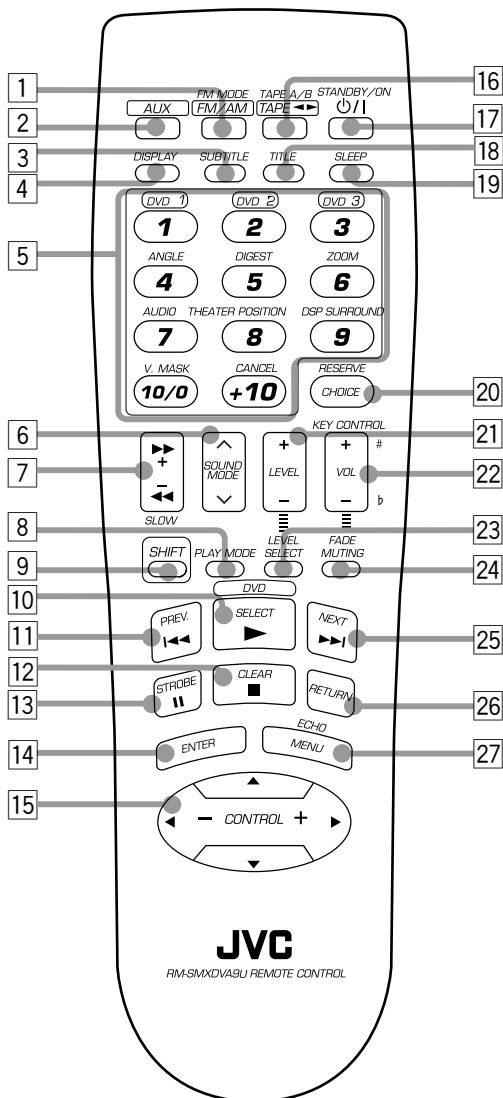

When using the remote control, point it at the remote sensor on the front panel.

Remote Control

- 1 FM/AM button (12, 15)
Pressing this button also turns on the unit.
FM MODE button* (15)
- 2 AUX button (12)
Pressing this button also turns on the unit.
- 3 SUBTITLE button (18)
- 4 DISPLAY button (17, 20, 22, 51)
- 5 Number buttons (15, 20 – 22, 25, 37, 43)
Disc number buttons* (DVD 1, DVD 2, and DVD 3)
(19, 21, 25, 26, 37)
ANGLE button* (17)
DIGEST button* (29)
ZOOM button* (28)
AUDIO button* (18, 36)
THEATER POSITION button* (29)
DSP SURROUND button* (31)
V. MASK button* (35, 37)
CANCEL button* (25, 37)
- 6 SOUND MODE \wedge / \vee button (13)
- 7 \lll / \ggg (fast reverse/fast forward) button (22, 30)
+ / - button (15)
SLOW + / - button (28)
- 8 PLAY MODE button (20 – 22, 24 – 27)
- 9 SHIFT button
- 10 DVD \blacktriangleright (play) button (12, 19 – 22, 25, 28, 36, 37)
Pressing this button also turns on the unit.
SELECT button (23, 29)
- 11 \lll (reverse search) button (20, 21)
PREV. (preview) button (29)
- 12 \blacksquare (stop) button (20, 21, 23, 25, 26, 30, 36, 37, 43)
CLEAR button (25, 37)
- 13 \parallel (pause) button (19, 28)
STROBE button (28)
- 14 ENTER button (20 – 22, 25 – 27, 29, 38 – 41, 43)
- 15 Cursor (\blacktriangle / \blacktriangledown / \blacktriangleright / \blacktriangleleft) button
(23, 28, 29, 37, 38, 40, 41, 43)
CONTROL + / - button (18, 20, 21, 22, 25 – 27)
- 16 TAPE \lll / \ggg button (12, 30)
Pressing this button also turns on the unit.
TAPE A/B button* (30)
- 17 STANDBY/ON \odot / I button (11)
- 18 TITLE button (23)
- 19 SLEEP button (47)
- 20 CHOICE button (38)
RESERVE button* (37)
- 21 LEVEL + / - button (12, 13, 31)
- 22 VOL (volume) + / - button (12, 35, 36)
KEY CONTROL # / \flat button* (35)
- 23 LEVEL SELECT button (12, 13, 31)
- 24 FADE MUTING button (12)
- 25 \ggg (forward search) button (20, 21, 25, 26)
NEXT button (29)
- 26 RETURN button (23)
- 27 MENU button (23)
ECHO button* (35)

* These buttons function while pressing with SHIFT.

Supplied Accessories

Make sure that you have all the following items. The number in the parentheses indicates the quantity of the pieces supplied.

- AM loop antenna (1)
- FM antenna (1)
- Remote control (1)
- Batteries (2)
- AC plug adaptor (1)
- Composite video cord (1)

If anything is missing, consult your dealer immediately.

Putting the Batteries into the Remote Control

Insert the batteries—R6(SUM-3)/AA(15F)—into the remote control, by matching the polarity (+ and –) on the batteries with the + and – markings on the battery compartment.

When the remote control can no longer operate the unit, replace both batteries at the same time.

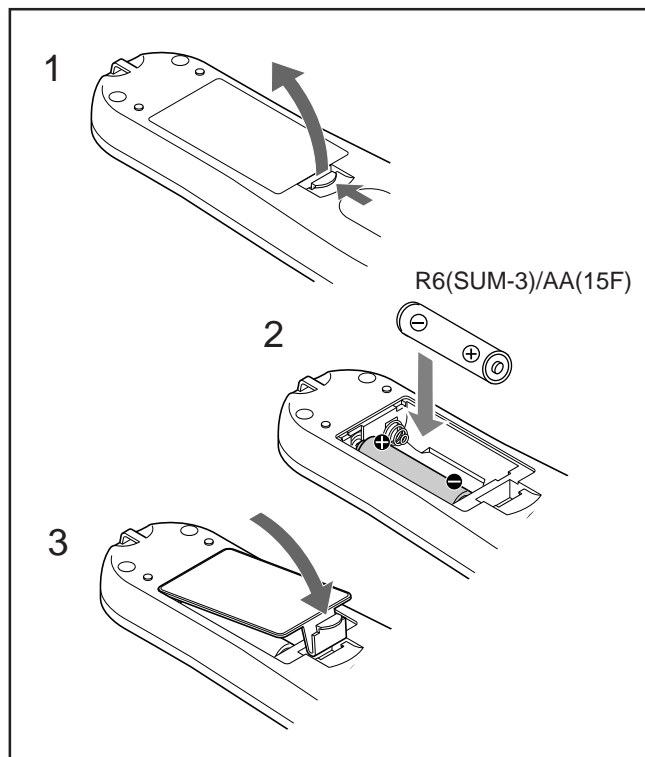

- DO NOT use an old battery together with a new one.
- DO NOT use different types of batteries together.
- DO NOT expose batteries to heat or flame.
- DO NOT leave the batteries in the battery compartment when you are not going to use the remote control for an extended period of time. Otherwise, it will be damaged from battery leakage.

Connecting Antennas

FM antenna

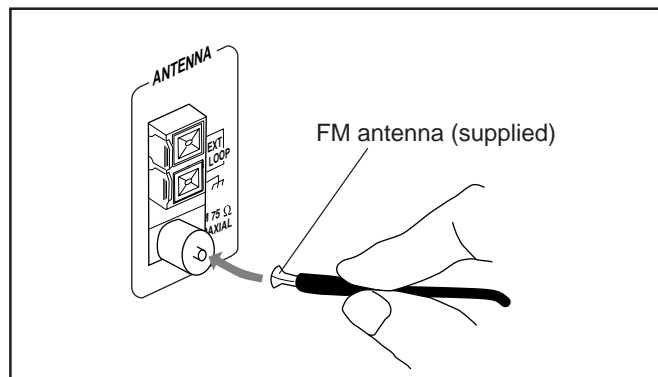

- 1 Attach the FM antenna to the FM 75 Ω COAXIAL terminal.
- 2 Extend the FM antenna.
- 3 Fasten it up in the position which gives you the best reception, then fix it on the wall, etc.



About the supplied FM antenna

The FM antenna supplied with this unit can be used as temporary measure. If reception is poor, you can connect an outdoor FM antenna.

To connect an outdoor FM antenna

Before connecting it, disconnect the supplied FM antenna.

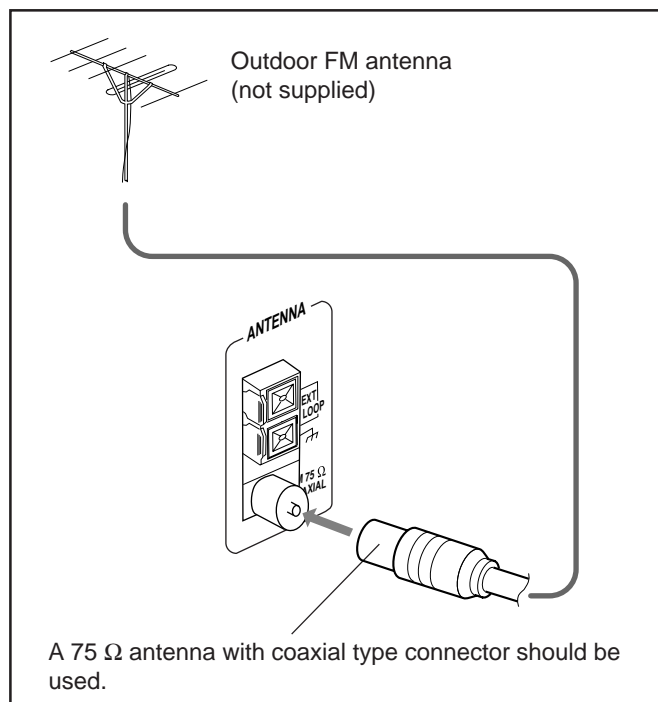

AM antenna

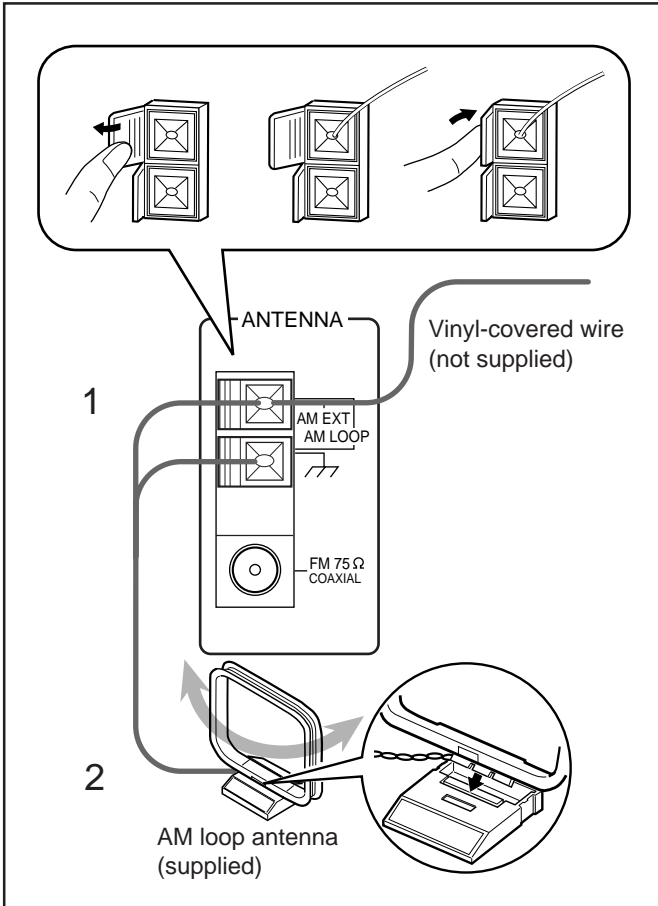

1 Connect the AM loop antenna to the AM LOOP terminals as illustrated.

- If the AM loop antenna wire is covered with vinyl, remove the vinyl by twisting it as shown in the diagram.



2 Turn the AM loop antenna until you have the best reception.

To connect an outdoor AM antenna

When reception is poor, connect a single vinyl-covered wire to the AM EXT terminal and extend it horizontally. The AM loop antenna must remain connected.



For better reception of both FM and AM

- Make sure the antenna conductors do not touch any other terminals and connecting cords.
- Keep the antennas away from metallic parts of the unit, connecting cords, and the AC power cord.

Connecting Speakers

IMPORTANT: Use only speakers with the same speaker impedance as indicated by the speaker terminals on the rear of the unit.

To connect front speakers

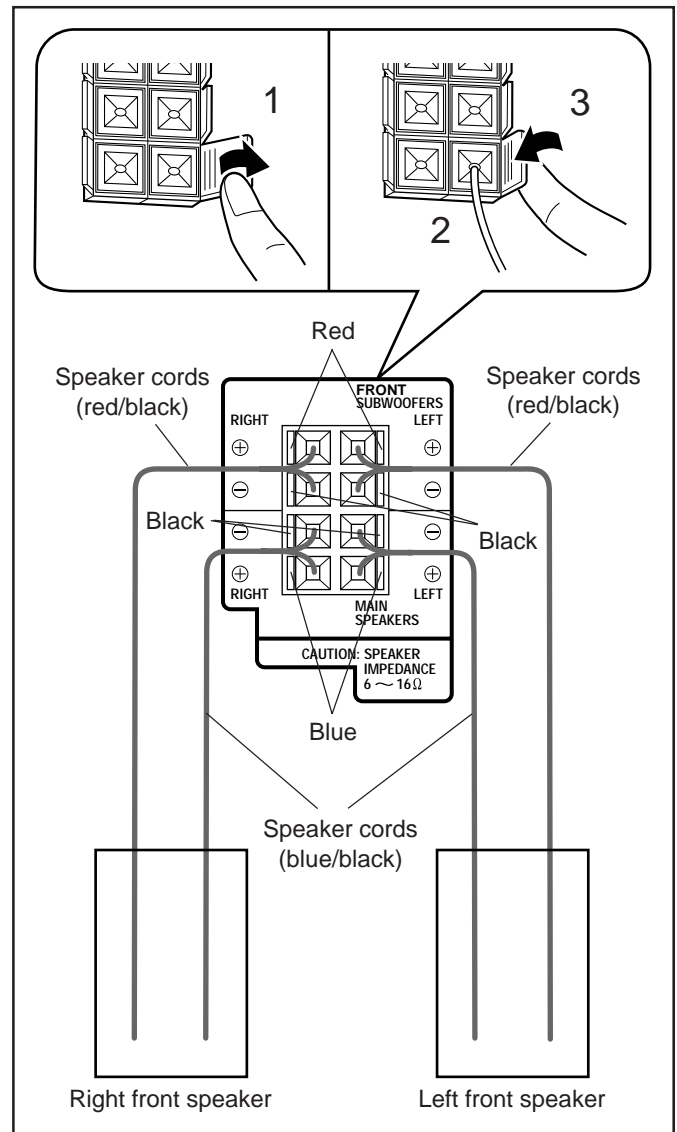

1 Open the speaker terminal.

2 Insert the end of the speaker cord into the terminal.

Match the polarity (colors) of the speaker terminals: Red (+) to red (+) and black (-) to black (-); Blue (+) to blue (+) and black (-) to black (-).

3 Close the speaker terminal.

To connect a center speaker and rear speakers

By connecting a center speaker and rear speakers to the SURROUND SPEAKERS jacks, you can enjoy Dolby Digital and MPEG Multichannel sound, and the DSP Surround modes. (See page 31.)

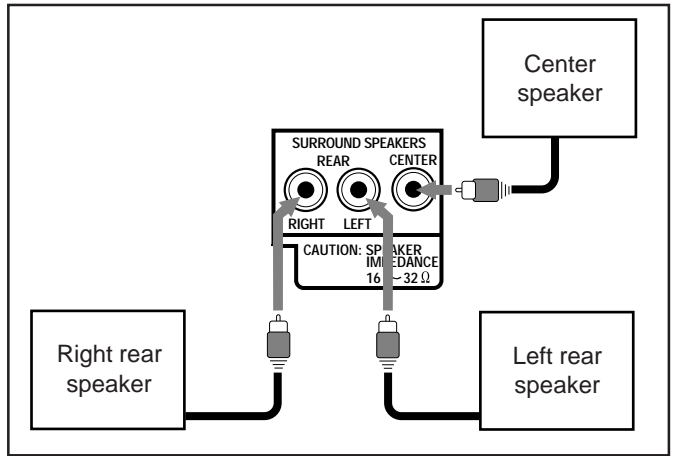

- Connect the right rear speaker to the REAR RIGHT jack.
- Connect the left rear speaker to the REAR LEFT jack.
- Connect the center speaker to the CENTER jack.

To connect a subwoofer

By connecting a subwoofer, you can reproduce the LFE signals recorded in multichannel software.

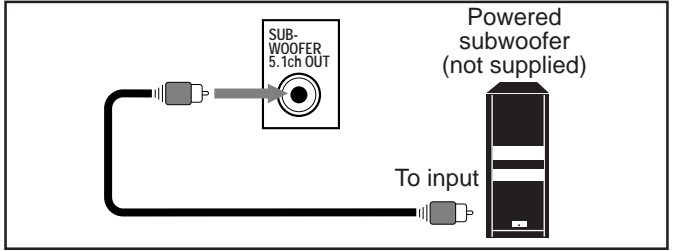

Connect the input jack of a powered subwoofer to the SUBWOOFER 5.1ch OUT jack, using a monaural audio cord (not supplied).



To prevent powered subwoofer from damaging

Set the powered subwoofer (not supplied) volume level to the minimum before selecting disc as a playing source. When playing a disc that has software with the LFE signals, then adjust the powered subwoofer volume to the desired level.

Ideal speaker layout

To enjoy multichannel sound, locate speakers as follows. If you cannot locate them like this, adjust the speaker setting by using the on-screen menu. (See page 40.)

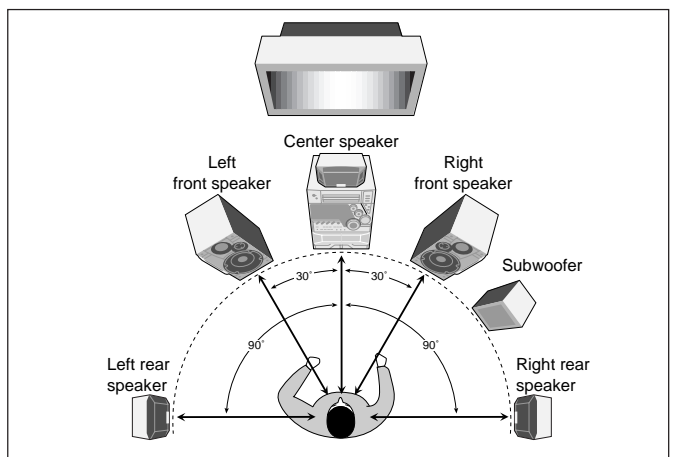

Connecting Other Equipment

You can connect both analog and digital equipment.



- DO NOT connect any equipment while the unit is on.
- DO NOT plug in any equipment until all connections are complete.

To connect an analog component

Be sure that the plugs of the audio cords are colored: White plugs and jacks are for left audio signals, and red ones for right audio signals.

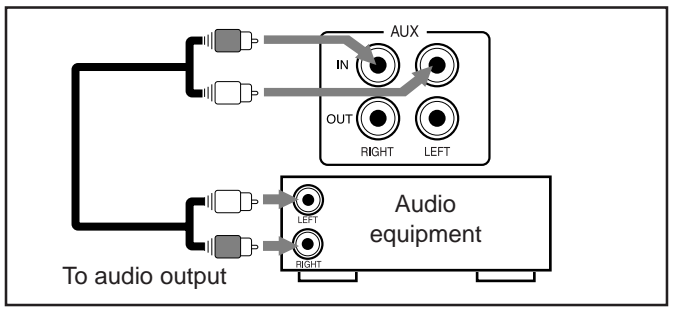

For playing the other equipment through this unit, connect between the audio output jacks on the other equipment and the AUX IN jacks by using audio cords (not supplied).

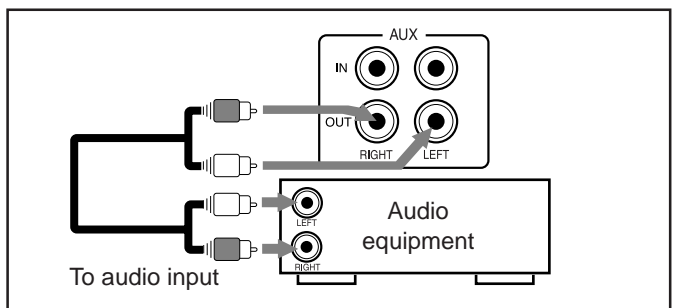

For recording sounds through this unit on the other equipment, connect between the audio input jacks on the other equipment and the AUX OUT jacks by using an audio cord (not supplied).

- See “About sounds output through the rear terminals” on the next page.

To connect audio equipment with an optical digital input terminal—such as digital decoder

You can connect a digital decoder such as an MD recorder or a CD recorder by using an optical digital cord (not supplied).

- See “About sounds output through the rear terminals” on the right.

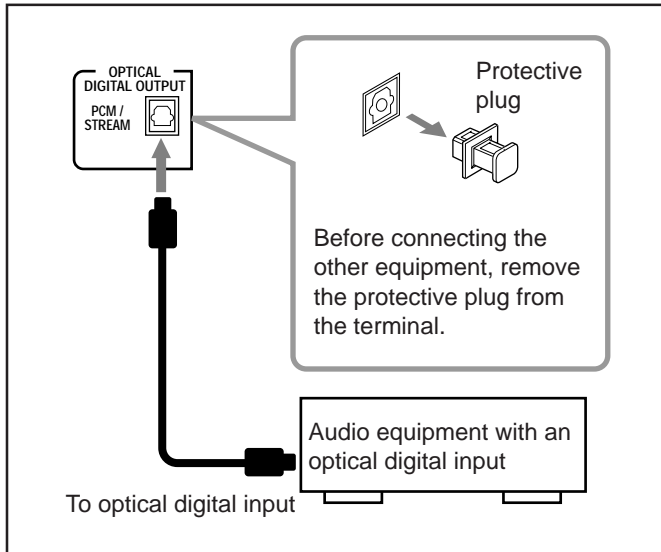



Connect an optical digital cord (not supplied) between the optical digital input terminal on the other equipment and the OPTICAL DIGITAL OUTPUT terminal.

About sounds output through the rear terminals

• Through the AUX OUT (RIGHT/LEFT) jacks:

Analog stereo signals are output.

When playing a source encoded with Dolby Digital*

() or with MPEG Multichannel () , multichannel signals are mixed to the right front and left front channels, then output. You also need to set “PRO LOGIC” setting correctly. (See page 39.)

– You cannot reproduce the sound encoded with DTS Digital Surround** ().

• Through the OPTICAL DIGITAL OUTPUT terminal:

Digital signals (Linear PCM, Dolby Digital*, DTS Digital Surround**, MPEG Multichannel) are output.

To reproduce the multichannel sounds such as Dolby Digital, DTS Digital Surround and MPEG Multichannel, connect an amplifier or a decoder compatible with these multichannel sources to this terminal, and set “DIGITAL AUDIO OUTPUT” setting correctly. (See page 39.)

* Manufactured under license from Dolby Laboratories.

“Dolby,” “Pro Logic,” “Dolby” and the double-D symbol are trademarks of Dolby Laboratories. Confidential unpublished works. Copyright 1992–1997 Dolby Laboratories. All rights reserved.

** Manufactured under license from Digital Theater Systems, Inc. US Pat. No. 5,451,942 and other world-wide patents issued and pending. “DTS,” and “DTS Digital Surround” are trademarks of Digital Theater Systems, Inc. Copyright 1996, 2000 Digital Theater Systems, Inc. All Rights Reserved.



To connect a TV

Connect your TV and this unit using the composite video cord (supplied) or an S-video cord (not supplied).

- You can also use JVC's AV COMPU LINK control system. (See page 48.)

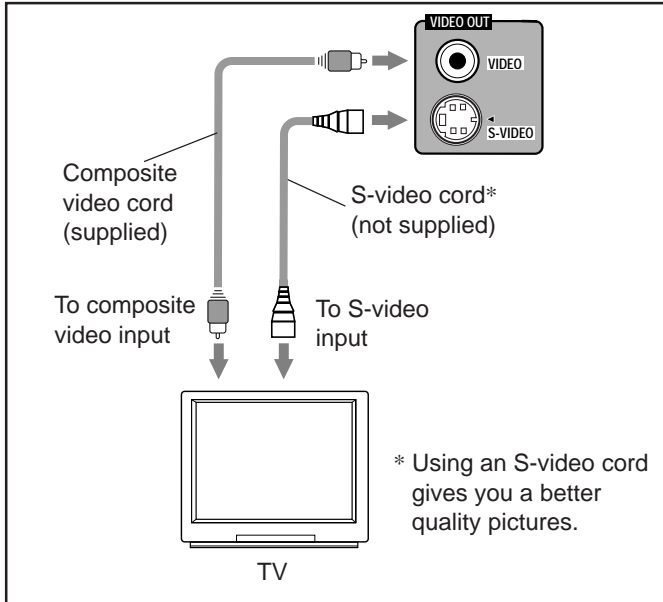

This unit is compatible with the color systems of PAL and NTSC. Check your TV's color system and select the correct one by pressing and holding SET while the unit is turned off (on standby). Each time you press and hold the button, "PAL" and "NTSC" appears alternately.

Adjusting the Voltage Selector

Before plugging in the unit, set the correct voltage for your area with the voltage selector on the rear of the unit.

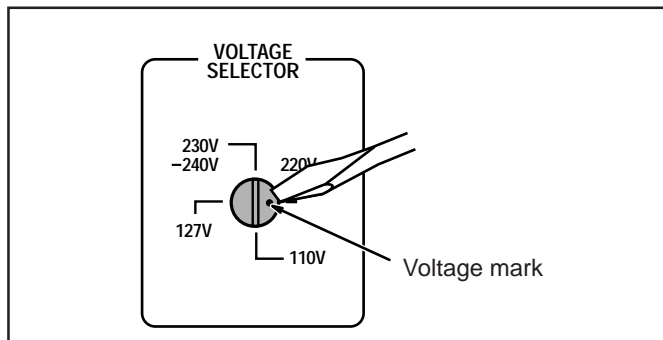

Use a screwdriver to rotate the voltage selector so the voltage number the voltage mark is pointing at is the same as the voltage where you are plugging in the unit. (See the back cover page.)

DO NOT plug in before setting the voltage selector on the rear of the unit and all connection procedures are complete.

Now, you can plug the AC power cord.

When connecting the AC power cord into a wall outlet, the unit automatically starts display demonstration.

- If the wall outlet does not match the AC plug, use the supplied AC plug adaptor.

IMPORTANT: Be sure to check all connections to be done before plugging the AC power cord into a wall outlet.

Canceling the Display Demonstration

On the unit ONLY:

To cancel the display demonstration, press CANCEL/DEMO until "DEMO OFF" appears on the display.



When you press other buttons

The display demonstration stops temporarily. It will start automatically again (if no operation is done for 2 minutes) unless you cancel it by pressing CANCEL/DEMO.

To start the display demonstration manually

Press and hold CANCEL/DEMO for more than 1 second.

Common Operations

Turning On or Off the Power

To turn on the unit, press STANDBY/ON  so that the STANDBY lamp goes off.

WELCOME

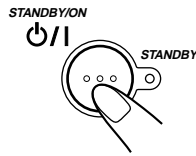

To turn off the unit (on standby), press STANDBY/ON  again so that the STANDBY lamp lights up.

GOODBYE

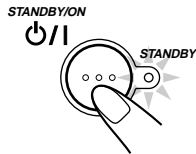

- A little power is always consumed even while the unit is on standby.

To switch off the power supply completely, unplug the AC power cord from the AC outlet.

notes When you unplug the AC power cord or if a power failure occurs

The clock is reset to “0:00” right away, while the tuner preset stations (see page 15) will be erased in a few days.

Setting the Clock

Before operating the unit any further, first set the clock built in this unit. You can set the clock whether the unit is on or off.

On the unit ONLY:

1 Press CLOCK/TIMER.

The hour digits start flashing on the display.



2 Turn / to adjust the hour, then press SET.

The minute digits start flashing on the display.

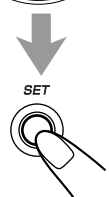
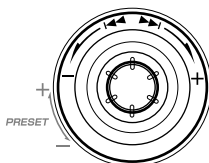

- If you want to correct the hour after pressing SET, press CANCEL/DEMO. The hour digits start flashing again.



3 Turn / to adjust the minute, then press SET.

CLOCK OK

To check the clock time

Press and hold SET while playing any source.

- Pressing SET, the source indication appears again.

To adjust the clock again

If you have adjusted the clock before, you need to press CLOCK/TIMER repeatedly until the clock setting mode is selected.

- Each time you press the button, the clock/timer setting modes change as follows:

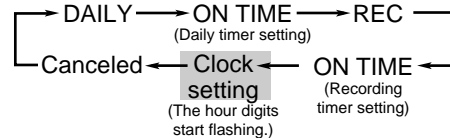

When you unplug the AC power cord or if a power failure occurs

The clock is reset to “0:00” right away. If this happens, set the clock again.

Setting the AM Tuner Interval Spacing

Some countries space AM stations 9 kHz apart, and some countries use 10 kHz spacing.

On the unit ONLY:

When shipped, the unit is set to 9 kHz spacing.

You can only change the AM tuner interval spacing while tuning into an AM station. (See page 15.)

Press STANDBY/ON  while holding down .

- Each time you press these buttons, the AM tuner interval spacing alternates between 9 kHz and 10 kHz.

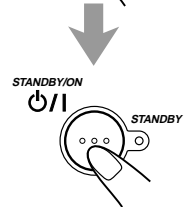

Selecting the Sources

To listen to the FM/AM broadcasts, press FM/AM. (See page 15.)

To playback discs, press DVD ►/|| (or DVD ► on the remote control). (See pages 16 – 29.)

To playback tapes, press TAPE ◀▶. (See page 30.)

To select the external equipment as the source, press AUX.

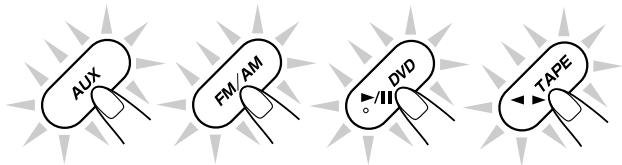

When you press the play button for a particular source (FM/AM, DVD ►/|| (or DVD ► on the remote control), TAPE ◀▶, and AUX), the unit turns on (and the unit starts playing the source if it is ready).

Adjusting the Volume

You can adjust the volume level only while the unit is turned on. The volume level can be adjusted in 32 steps (VOL MIN, VOL 01—VOL 30, and VOL MAX).

Turn VOLUME + / – clockwise (+) to increase the volume or counterclockwise (–) to decrease it.

VOL 15

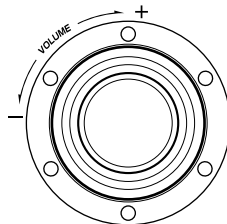

When using the remote control, press VOL + to increase the volume or press VOL – to decrease it.



For private listening

Connect a pair of headphones to the PHONES jack. No sound comes out of the speakers. Be sure to turn down the volume before connecting or putting on headphones.



DO NOT turn off (on standby) the unit with the volume set to an extremely high level; otherwise, a sudden blast of sound can damage your hearing, speakers and/or headphones when you turn on the unit or start playing any source next time. REMEMBER you cannot adjust the volume level while the unit is off (on standby).

To turn down the volume level temporarily

Press FADE MUTING on the remote control.

The volume level gradually decreases to “VOL MIN.”

To restore the sound, press the button again.



Adjusting the Front Speaker Output Balance

If the sounds you hear from the front right and left speakers are unequal, you can adjust the speaker output balance.

On the remote control ONLY:

1 Press LEVEL SELECT until “L” and “R” appear on the display.

Initially the front speakers output balance is set to the center.

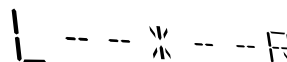

2 Press LEVEL + or – to adjust the front speaker output balance.

- Press LEVEL + to increase the right channel output.
- Press LEVEL – to increase the left channel output.

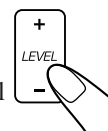

Reinforcing the Bass Sound

You can select one of the 4 subwoofer levels. This function only affects the playback sound, but does not affect your recording. The subwoofer level can be adjusted in 4 steps—LEVEL 1, LEVEL 2, LEVEL 3, and LEVEL 4 (MAX LEVEL).

Turn **SUBWOOFER LEVEL** + / – clockwise (+) to increase the subwoofer level or counterclockwise (–) to decrease it.



When using the remote control, press **LEVEL SELECT** until “LEVEL” appears.

- Press **LEVEL +** to increase the subwoofer level.
- Press **LEVEL –** to decrease the subwoofer level.

SUBWOOFER indicator flashes when adjusting subwoofer level.

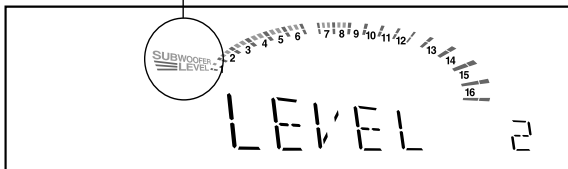

Selecting the Sound Modes

You can select one of the 6 preset sound modes. This function only affects the playback sound, but does not affect your recording.

To select the sound modes, turn **SOUND MODE** until the sound mode you want appears on the display.

When using the remote control, press **SOUND MODE** \wedge or \vee .

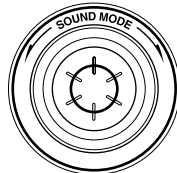

The **SOUND MODE** indicator also lights up on the display.

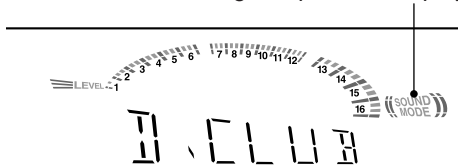

- The sound modes change as follows:

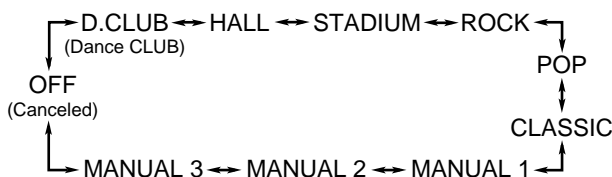

D.CLUB*: Increases resonance and bass.

HALL*: Adds depth and brilliance to the sound.

STADIUM*: Adds clarity and spreads the sound, like in an outdoor stadium.

SEA (Sound Effect Amplifier) modes:

ROCK: Boosts low and high frequency. Good for acoustic music.

POP: Good for vocal music.

CLASSIC: Good for classical music.

Manual modes:

MANUAL 1/2/3:

Your individual mode stored in memory. See “Creating Your Own Sound Modes—Manual Mode” on page 14.

OFF: The sound mode is canceled. The **SOUND MODE** indicator goes off.

- * Surround elements are added to the SEA element to create a being-there feeling in your room.

When one of these modes is selected, the **SOUND MODE** indicator lights up as — 

While one of the SEA modes (including manual modes) without surround elements is selected, the **SOUND MODE** indicator lights up as — 

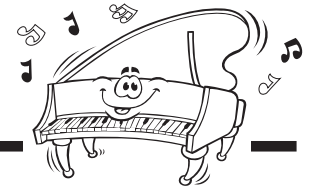

Creating Your Own Sound Modes —Manual Mode

You can create SEA patterns to suit your preference. These changed settings can be stored in the MANUAL 1, MANUAL 2, and MANUAL 3 modes.

- There is a time limit in doing the following steps. If the setting is canceled before you finish, start from step 1 again.

On the unit ONLY:

- 1 Select one of the preset sound modes.
 - If you want to add the surround elements in your SEA pattern, select one of the sound modes (D.CLUB, HALL, or STADIUM) before starting the procedure below. (See “Selecting the Sound Modes” on page 13.)

- 2 Press and hold SET until “SEA CONT” appears on the display.

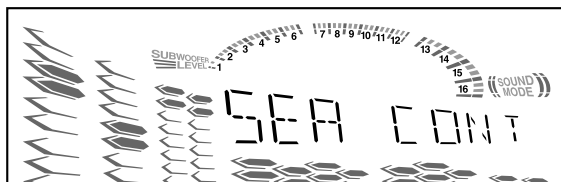

Ex.: When “D.CLUB” is selected as the sound mode.

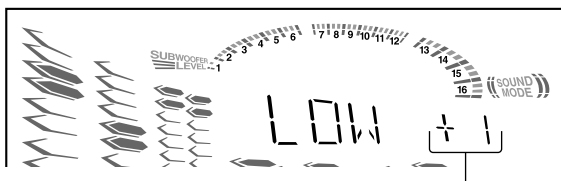

Current level appears.

- 3 Adjust the SEA pattern.

- 1) Turn |◀◀ / ▶▶| to select the frequency range to adjust (LOW, MID or HIGH).
- 2) Press ▶▶ or ◀◀ to adjust the level (–3 to +3) of the selected frequency range.
- 3) Repeat steps 1) and 2) to adjust the level of the other frequency ranges.

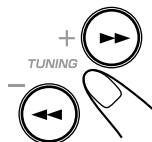
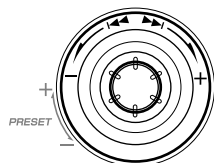

- 4 Press SET again.

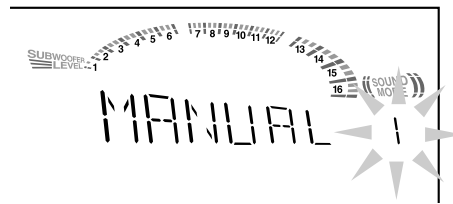
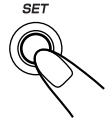

- 5 Turn |◀◀ / ▶▶| to select one of the MANUAL 1, MANUAL 2, and MANUAL 3 modes into which you want to store the SEA pattern.

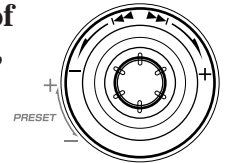

- 6 Press SET.

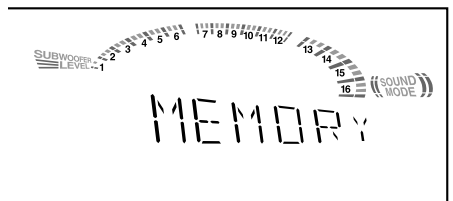
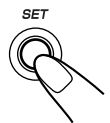

The SEA pattern you have created is stored into the MANUAL mode selected in step 5.

To use your own sound mode

Select MANUAL 1, MANUAL 2, or MANUAL 3 mode. See “Selecting the Sound Modes” on page 13.



When you unplug the AC power cord or if a power failure occurs

The setting will be erased in a few days. If this happens, set the manual sound modes again.



Listening to FM and AM Broadcasts

Tuning into a Station

1 Press FM/AM.

The unit automatically turns on and tunes into the previously received station (either FM or AM).

- Each time you press the button, the band alternates between FM and AM.



2 Start searching for stations.

On the unit:

Press and hold TUNING + or - for more than 1 second.

On the remote control:

Press and hold + (▶▶) or - (◀◀) for more than 1 second.

The unit starts searching for stations and stops when a station of sufficient signal strength is tuned in.

- If a program is broadcast in stereo, the ST (stereo) indicator lights up.

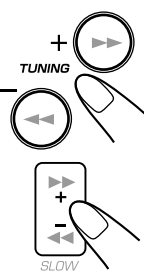

On the unit ONLY:

1 Tune into the station you want to preset.

- See "Tuning into a Station."

2 Press SET.



3 Turn PRESET + / - to select a preset number.

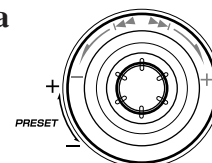
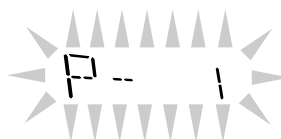

4 Press SET.

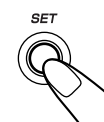

The tuned station in step 1 is stored in the preset number selected in step 3.

- Storing a new station on a used number erases the previously stored one.

To stop searching, press TUNING + or - (+ ▶▶) or - (◀◀) on the remote control).



When you press TUNING + or - (+ ▶▶) or - (◀◀) on the remote control) briefly and repeatedly

The frequency changes step by step.



When you unplug the AC power cord or if a power failure occurs

The preset stations will be erased in a few days. If this happens, preset the stations again.

To change the FM reception mode

When an FM stereo broadcast is hard to receive or noisy, press FM MODE while holding down SHIFT on the remote control so that the MONO indicator lights up on the display. Reception improves.



To restore the stereo effect, press FM MODE again while holding down SHIFT so that the MONO indicator goes off from the display. In stereo mode, you can hear stereo sounds when a program is broadcasted.

Presetting Stations

You can preset 30 FM and 15 AM stations.

In some cases, test frequencies have been already memorized for the tuner since the factory examined the tuner preset function before shipment. This is not a malfunction. You can preset the stations you want into memory by following the presetting method.

- There is a time limit in doing the following steps. If the setting is canceled before you finish, start from step 2 again.

Tuning into a Preset Station

1 Press FM/AM.

The unit automatically turns on and tunes into the previously received station (either FM or AM).

- Each time you press the button, the band alternates between FM and AM.



2 Select a preset number.

On the unit:

Turn PRESET + / -.

On the remote control:

Press the number buttons.

Ex.: For preset number 5, press 5.

For preset number 15, press +10, then 5.

For preset number 20, press +10, then 10.

For preset number 25, press +10, +10, then 5.

For preset number 30, press +10, +10, then 10.

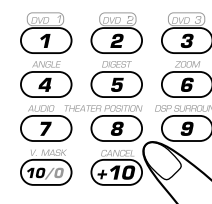
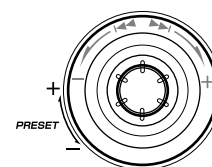







Playing Back Discs—Introduction

Continued 

Discs you can play

This unit has been designed to play back discs having the marks listed below.

Disc Type	Mark (Logo)	Video Format	Region Code Number	
DVD VIDEO		NTSC PAL	2, 3, 4 or ALL	
				
Video CD			_____	
S-Video CD			_____	
Audio CD			_____	_____
CD-R**			_____	_____
CD-RW**		_____	_____	

- On some discs, their actual operations may be different from what is explained in this manual.
- The following discs cannot be played back; DVD-AUDIO, DVD-ROM, DVD-RAM, DVD-R, DVD-RW, CD-ROM, CD-I (CD-I Ready), Photo CD, etc. Playing back these discs will generate noise and damage the speakers.
- Continued use of irregular shape discs (heart-shape, octagonal, etc.) can damage the unit.

* Note on Region Code

DVD players and DVD Video discs have their own Region Code numbers. Confirm the Region Code shown on the rear of the unit.

Ex.:



** Note on CD-R and CD-RW

User-edited CD-Rs (CD-Recordable) and CD-RWs (CD-Rewritable) can be played back only if they are already “finalized.”

- You can play back your original CD-Rs or CD-RWs recorded in music CD format. (However, they may not be played back depending on their characteristics or recording conditions.)
- Before playing back CD-Rs or CD-RWs, read their instructions or cautions carefully.
- Some CD-Rs or CD-RWs may not be played back on this unit because of their disc characteristics, damage or stain on them, or if the player’s lens is dirty.
- CD-RWs may require a longer readout time. This is caused by the fact that the reflectance of CD-RWs is lower than for regular CDs.

IMPORTANT:

Before performing any operations for DVD, SVCD and VCD, make sure of the following.

- Check the connection with the TV.
- Turn on the TV and select the correct input on the TV to view the pictures or on-screen menus/indications on the TV screen.
- Select the correct color system.

If “” appears on the screen when pressing a button, the disc cannot accept an operation you have tried to do.

Disc Structure

DVD

A DVD disc consists of **Titles**, and each title may be divided into some **Chapters**.

For example, if a DVD disc contains some movies, each movie may have its own title number, and it may be further divided into some chapters.

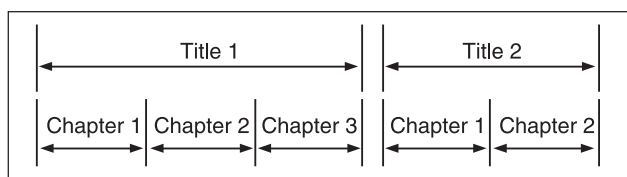

How sounds are recorded on DVD

The digital audio format used for DVD differs among discs and it is written on the package or disc itself.

This unit can only reproduce the sound recorded in the following audio formats:

- **Linear PCM**—This is the same format used for Audio CDs and Video CDs.
- **Dolby Digital**—This is an encoding method for audio signals. By compressing audio signals, it can record up to 5.1 multichannel signals—the right front channel, left front channel, center channel, and right rear channel, left rear channel and LFE signals.
 - While playing back a disc encoded with Dolby Digital on this unit, the DOLBY DIGITAL lamp on the front panel lights up. If it has multichannel signals—5.1ch, Surround mode is automatically activated.
- **MPEG Multichannel**—This is a compression format for PAL/SECAM DVD software. MPEG Multichannel is 5.1ch multi surround using MPEG Audio coding format.

SVCD, VCD and CD

A SVCD, VCD or CD disc consists of **Tracks**.

In general, each song has its own track number. (On some discs, each track may also be divided by Indexes.)

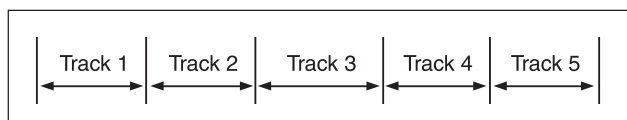

When playing back a SVCD or VCD with the Playback Control (PBC*) function, you can select what to view using the menu shown on the TV screen. While operating a SVCD or VCD using the menu, some of the functions such as Time Search may not work.

* A SVCD and VCD recorded with the PBC function has its own menus, such as a list of the songs of the disc.

DVD Features

Some DVDs contain several multi-angle views, audio languages and subtitles.

When you find the following marks on the DVD or its package, you can select these elements recorded on the DVD.

	Multi-angle views are recorded on the disc. The number inside the mark indicates the total number of the recorded multi-angle views.
	Several audio languages are recorded on the disc. The number inside the mark indicates the total number of the recorded audio languages.
	Subtitles are recorded on the disc. The number inside the mark indicates the total number of the recorded subtitles.

To check the current settings, press DISPLAY once while playing back a disc. Current disc information appears on the TV screen as follows. And also the current channel information appears on the display by pressing DISPLAY on the unit. (See page 51).

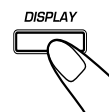

• If you press the button twice, the disc playing information appears. (See page 20.)

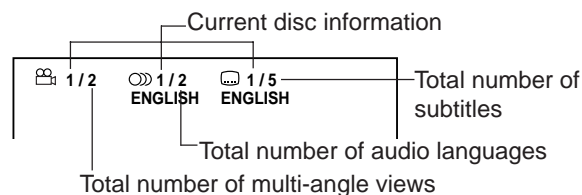

To erase the on-screen indication, press DISPLAY repeatedly until the indications disappear from the TV screen.

Selecting the Multi-Angle View

For DVD only

While playing a disc containing multi-angle views, you can view the same scene at different angles.

On the remote control ONLY:

1 Press ANGLE while holding down SHIFT.

The on-screen indication appears on the TV.



2 Press CONTROL + or - to select a desired multi-angle view.

- Each time you press the button, the view angle changes.

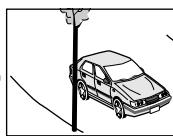
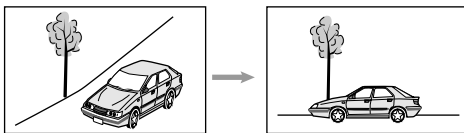
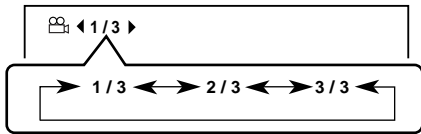
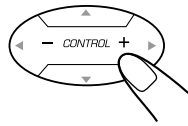

Ex.: When the disc has 3 multi-angle views.

Selecting the Audio Language or Sound

For DVD, SVCD and VCD

While playing a disc containing audio languages (sound tracks), you can also select the language (sound) to listen to.

- You can set your favorite audio language for DVD as the initial audio language. (See page 39).

On the remote control ONLY:

1 Press AUDIO while holding down SHIFT.

The on-screen indication appears on the TV.

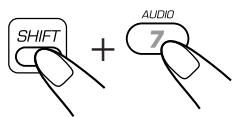

2 Press CONTROL + or - to select a desired audio language.

- Each time you press the button, the audio language changes.

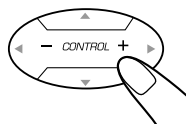

For DVD

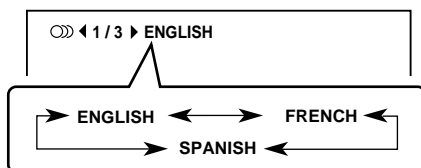

Ex.: When the disc has 3 selections—English, French, and Spanish.

For SVCD

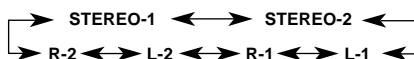

For VCD



Selecting the Subtitle

For DVD and SVCD

While playing a disc containing subtitles in different languages, you can select the subtitle to be displayed on the TV screen.

- You can set your favorite subtitle language as the initial language shown on the screen. (See page 39.)

On the remote control ONLY:

1 Press SUBTITLE.

The on-screen indication appears on the TV.

- Each time you press the button, the subtitle setting turns on and off.



2 Press CONTROL + or - to select a desired subtitle language.

- Each time you press the button, the subtitle language changes.

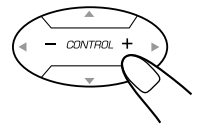

For DVD

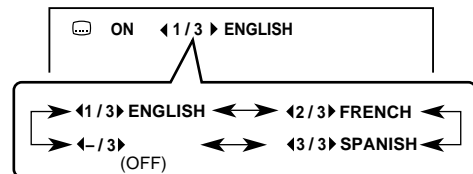

Ex.: When the disc has 3 selections—English, French, Spanish and no subtitle (OFF).

For SVCD

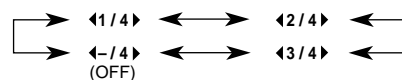

4 subtitle channels are shown even though the subtitle is recorded or not.

To show no subtitle, select “-.”

Basic Disc Playback

This unit cannot accept any disc operations while reading disc contents.

Loading Discs

On the unit ONLY:

- 1 Press **▲** for the disc tray (DVD1, DVD2, or DVD3) you want to load a disc onto.

The unit automatically turns on and the disc tray comes out.

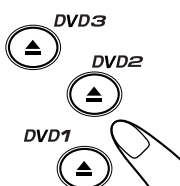

- 2 Place a disc correctly on the circle of the disc tray, with its label side up.

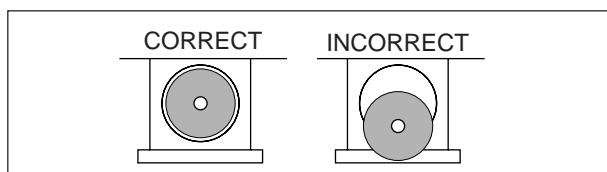

- When using a single disc (8 cm), place it on the inner circle of the disc tray.

- 3 Press the same **▲** you have pressed in step 1.

The disc tray closes, and the corresponding disc number lamp and disc indicator light up on the display.

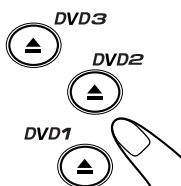

- 4 Repeat steps 1 to 3 to place other discs.



When loading more than one disc continuously

When you press **▲** for the next tray you want to place another disc onto, the first disc tray automatically closes and then the next tray comes out.



About the disc indicators

Each disc indicator corresponds to the disc tray of the same number.

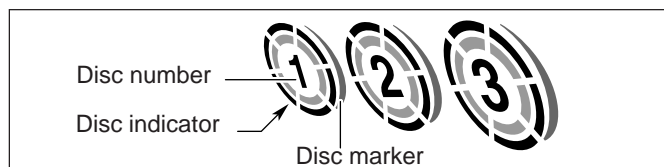

- The disc marker lights up for the disc number you have selected.
- The disc indicator rotates while the corresponding disc is being played.
- The disc indicator goes off when the unit has detected that there is no disc on the corresponding disc tray.



SVCD/VCD/CD playback sequence during Continuous play

When 3 SVCDs, VCDs or CDs are loaded on the disc trays, they are played in one of the following sequences.

- When DVD1 is pressed : DVD1 ⇒ DVD2 ⇒ DVD3 (then stops)
- When DVD2 is pressed : DVD2 ⇒ DVD3 ⇒ DVD1 (then stops)
- When DVD3 is pressed : DVD3 ⇒ DVD1 ⇒ DVD2 (then stops)

* When only 2 SVCDs, VCDs or CDs are loaded, they are played in the same order, but the disc tray without a disc is skipped.

* This function cannot be used for SVCD or VCD with the PBC function and DVD.

Common Basic Disc Operations

While playing a disc, you can do the following operations.

To exchange discs during playback of another

Press **▲** corresponding to a disc, not playing or selected currently, to eject and exchange the disc.

If you exchange discs during play, the current play will not stop.

To stop play for a moment

Press DVD **▶/||** (or **||** on the remote control).

While pausing, the elapsed playing time flashes on the display.

To resume playing, press DVD **▶/||** again (or press DVD **▶** on the remote control).

DVD Playback

- To play back a SVCD, VCD or CD see page 21.
- Playback will stop when a disc menu appears on the TV screen. If a menu appears while playing, see “Menu-Driven Playback” on page 23.

1 Load discs.

2 Select the disc number button you want to play.

On the unit:

Press one of the disc number buttons (DVD1, DVD2, or DVD3)



On the remote control:

Press one of the disc number buttons (DVD 1, DVD 2, or DVD 3) while holding down SHIFT.

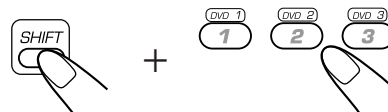

The unit starts reading the disc contents and “DVD” is shown on the display. Then the total title number appears.

- Playback starts from the first chapter of the first title and the disc number lamp starts flashing.

While playing back a disc encoded with Dolby Digital, the DOLBY DIGITAL lamp on the front panel lights up. If it has multichannel signals—5.1ch, the Surround mode is automatically activated.

While playing back an MPEG Multichannel disc, the Surround mode is automatically activated.

- Using the on-screen menus, you can adjust the speaker settings for 5.1ch Surround mode depending on your room situation. (See page 40.)
- While playing back a multichannel disc, the front left and the front right signals are output when—
—hearing a disc through headphones.
—hearing a disc through AUX OUT jacks.
—recording onto tapes.
- You can also confirm the current channel setting by pressing DISPLAY on the unit. (See page 51.)

Title numbers of the currently playing disc.
(Numbers exceeding 16 are not displayed.)

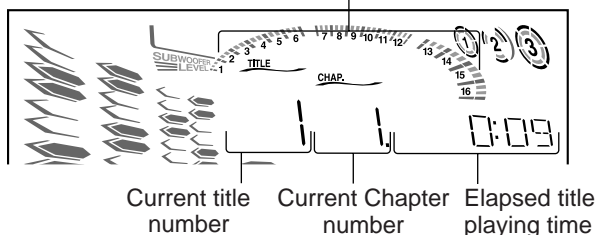

To stop playing, press ■.

- This unit can memorize the stop point of DVD, and when you start playback again by pressing DVD ►/|| (or DVD ► on the remote control), playback starts from the beginning of a chapter previously stopped—Resume play. To use Resume play, you need to turn on the Resume function. (See page 42.)
- To stop completely, press ■ twice.

To remove the disc, press ▲ for the corresponding disc tray.

To go to another chapter

Turn ◀◀◀/▶▶▶ during playback (or press ◀◀◀ or ▶▶▶ on the remote control).

- ◀◀◀: Goes back to the beginning of the current or previous chapters.
- ▶▶▶: Skips to the beginning of the next or succeeding chapters.

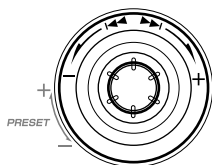

To go to a particular title or chapter directly using the number buttons on the remote control

- Pressing the number buttons before playback allows you to start playing from the title number you want.
- Pressing the number buttons during playback allows you to start playing from the chapter number of the currently playing title you want.

- Ex.: To select number 5, press 5.
To select number 10, press 10.
To select number 20, press +10 then 10.
To select number 23, press +10, +10 then 3.

To use Time Search and Chapter Search on the TV screen

- You cannot use this function while using Random play.

On the remote control ONLY:

1 Press PLAY MODE during play.
The play mode screen appears.

2 Press CONTROL + or - to move to “TIME SEARCH” or “CHAP. SEARCH,” then press ENTER.

“GO TO _: _: _” for Time Search or “GO TO CHAPTER = ” for Chapter Search appears on the TV screen.

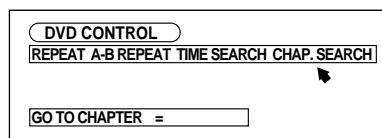
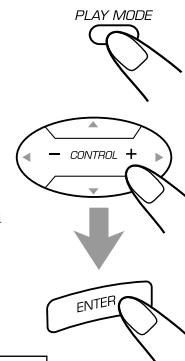

Ex.: When “CHAP. SEARCH” is selected.

3 Enter desired playing time or chapter number by pressing the number buttons.

- You can only use Time Search within a currently playing title.

Ex.: To enter the time of “0:23:45,” press 0, 2, 3, 4 and 5. (Always enter all 5 digits.)

To enter chapter number 23, press 2 and 3.
To enter chapter number 3, press 3.

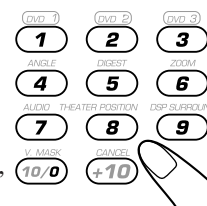

To cancel misentry for Time Search, press CONTROL -. Each time you press the button the last number you entered is erased. (You cannot erase a chapter number.)

4 Press ENTER.

The unit starts playback of the selected point.



To erase the on-screen indication, press PLAY MODE again.

To show the on-screen indication

You can show the following information on the TV screen while playing back a disc.

To show the on-screen indication, press DISPLAY while playing a disc.

- Each time you press the button, the indication on the TV screen changes as follows:

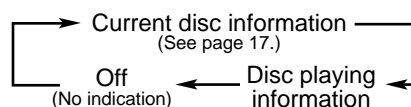
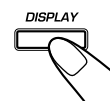

①	Current disc number			
②	Current title number			
③	Current chapter number			
④	Elapsed playing time of the current title			
⑤	Transmission rate			

SVCD/VCD/CD Playback

- To play back a DVD see page 19.
- While playing a SVCD or VCD with the PBC function loaded on the disc trays, the playback will stop when a disc menu appears. **If a menu appears while playing a SVCD or VCD with PBC function, see “Menu-Driven Playback” on page 23.**

1 Load discs.

2 Select the disc number button you want to play.

On the unit:

Press one of the disc number buttons (DVD1, DVD2, or DVD3).



On the remote control:

Press one of the disc number buttons (DVD 1, DVD 2, or DVD 3) while holding down SHIFT.

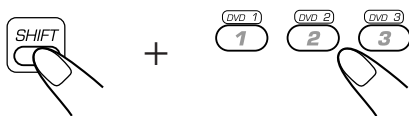

The unit starts reading the disc contents and “SVCD,” “VCD” or “CD” is shown on the display. Then the total playing time appears. (When SVCD or VCD with the PBC function is loaded, only “PBC” appears.) Playback starts from the first track of the selected disc and the disc number lamp starts flashing.

Track numbers of the currently playing disc. (Numbers exceeding 16 are not displayed.)

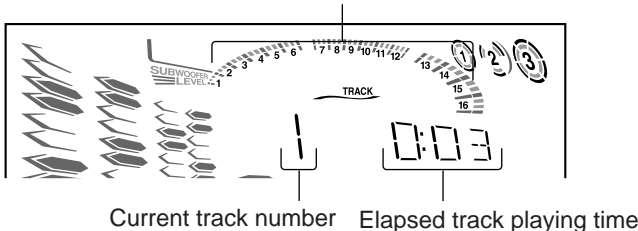

To stop playing, press ■.

- This unit can memorize the stop point of SVCD and VCD, and when you start SVCD or VCD playback again by pressing DVD ►/|| (or DVD ► on the remote control), playback starts from where it has been stopped—Resume play. When using Resume play on SVCD or VCD with the PBC function, the playback starts from the earlier point you stop.
To use Resume play, you need to turn on the Resume function. (See page 42.)
- To stop completely, press ■ twice.

To remove the disc, press ▲ for the corresponding disc tray.

To go to another track

Turn ◀◀◀ / ▶▶▶ during playback (or press ◀◀◀ or ▶▶▶ on the remote control).

- ◀◀◀: Goes back to the beginning of the current or previous tracks.
- ▶▶▶: Skips to the beginning of the next or succeeding tracks.

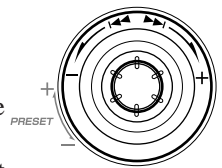

To go to a particular track directly using the number buttons on the remote control

Pressing the number buttons before or during play allows you to start playing from the track number you want.

Ex.: To select number 5, press 5.

To select number 10, press 10.

To select number 20, press +10 then 10.

To select number 23, press +10, +10 then 3.

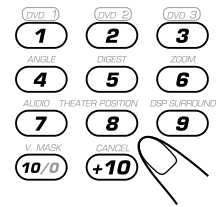

To use Time Search on the TV screen

- You cannot use this function while a SVCD or VCD with the PBC function is played back.
- You cannot use this function while using Random play.

On the remote control ONLY:

1 Press PLAY MODE during play.

The play mode screen appears.



2 Press CONTROL + or - to move to “TIME SEARCH,” then press ENTER.

“GO TO _: _: _:” appears on the TV screen.

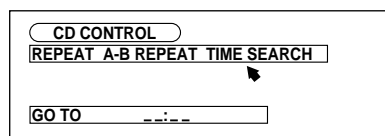
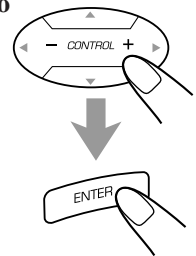

Ex.: When CD is a playing source.

3 Enter desired playing time by pressing the number buttons.

- You can only use Time Search within a currently playing track.
- Ex.: To enter the time of "03:45," press 0, 3, 4 and 5. (Always enter all 4 digits.)

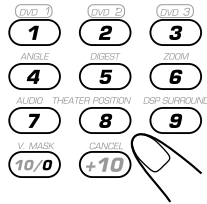

To cancel misentry for Time Search, press CONTROL -. Each time you press the button the last number you entered is erased.

4 Press ENTER.

The unit starts playback from the selected point.

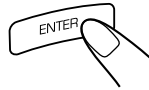

To erase the on-screen indication, press PLAY MODE again.

To show the on-screen indication

You can show the following information on the TV screen while playing back a disc.

To show the on-screen indication, press DISPLAY while playing a disc.

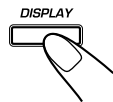

<p>Ex.: When SVCD or VCD with the PBC function is a playing source.</p>
①: Current disc number
②: Current track number
③: Elapsed playing time of the current track
④: • "PBC" is shown when a SVCD or VCD with the PBC function is played. • "EACH" is shown when a SVCD or VCD without the PBC function or a CD is played.

To erase the on-screen indication, press DISPLAY again.

Searching for a Particular Point

You can search for a particular portion while playing a disc — Forward/Reverse Search.

Forward Search

To fast-forward the chapter or track, press ►► while playing a disc.

- Each time you press the button, the search speed changes as follows:

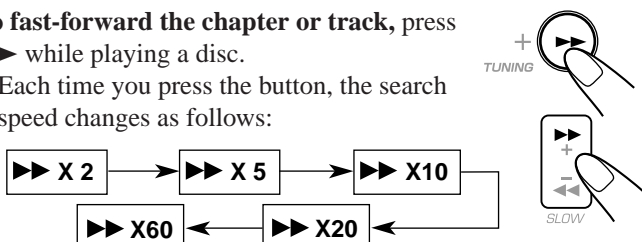

Reverse Search

To fast-reverse the chapter or track, press ◀◀ while playing a disc.

- Each time you press the button, the search speed changes as follows:

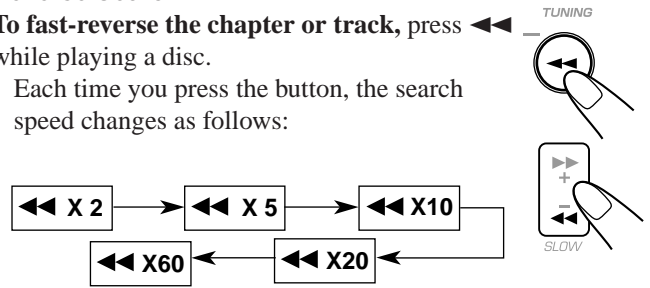

To go back to normal play, press DVD ►/|| (or DVD ► on the remote control).

No sound comes out during Forward/Reverse Search.

Prohibiting Disc Ejection—Tray Lock

You can prohibit disc ejection from the unit and can lock discs.

- This operation is possible only when the source is the DVD/SVCD/VCD/CD player.

On the unit ONLY:

To prohibit disc ejection, press ▲ for any disc tray while holding down ■. (If there is any disc tray opened, close it first.)

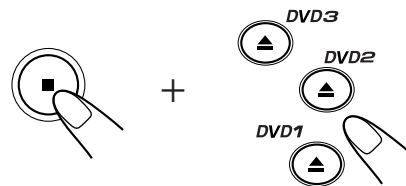

"LOCKED" appears for a while, and the loaded discs are locked.

To cancel the prohibition and unlock the discs, press ▲ for any disc tray while holding down ■.

"UNLOCKED" appears for a while, and the loaded discs are unlocked.



If you try to eject discs

"LOCKED" appears to inform you that the Tray Lock is in use.

Menu-Driven Playback

Menu Operations

Menu-driven playback is possible while playing back a DVD with menu-driven features or a SVCD or VCD with the Playback Control (PBC) function.

■ When playing a DVD

DVD discs generally have their own menus or title lists. A menu usually contains various information about the disc and playback selections. On the other hand, a title list usually contains titles of movies and of songs recorded.

On the remote control ONLY:

1 Press MENU or TITLE.

A menu or title list appears on the TV screen.

- On some discs, a menu or title list automatically appears without pressing MENU or TITLE.

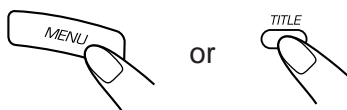

2 Press Cursor (▲ / ▼ / ► / ◀) to select a desired item on the menu or on the title list, then press SELECT.

The unit starts playback of the selected item.

- On some discs, you can also select items by pressing the number buttons corresponding to the item numbers listed.

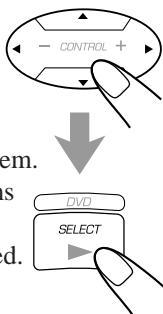

To erase the menu or title list

Press MENU or TITLE.

- If “⊘” appears on the screen when pressing TITLE in step 1, the disc does not have a menu listing titles.
- If “⊘” appears on the screen when pressing MENU in step 1, the disc does not have a menu. You can use MENU only while playing a disc.

■ When playing a SVCD or VCD

When a SVCD or VCD with the Playback Control function (PBC) is detected, the PBC indicator lights up on the display. The PBC function allows you to operate the SVCD or VCD using menus.

When you start playback, a menu automatically appears on the TV screen.

- A menu may be a list of items, divided screens, or some moving pictures. (See “PBC operation concept” on the right.)

To return to the previous menu

Press RETURN.

To cancel the PBC function

Press ■ to stop playback, then press MENU.

- Each time you press MENU, the PBC function turns on and off alternately.

To restore the PBC function, press REPEAT on the unit repeatedly until the REPEAT indicator goes off from the display. Then press DVD 1, DVD 2 or DVD 3 to play a SVCD or VCD with the PBC function.

- If you press DVD ►/|| on the unit or SELECT on the remote control when the PBC indicator on the display is turned off and a SVCD or VCD disc stops playing, the SVCD or VCD will be played back with the PBC function off.



While playing back a SVCD or VCD with the PBC function

A-B Repeat is only usable as the playing back mode.



Even though you turn on the PBC function while a SVCD or VCD is played back.

The PBC function remains off.

PBC operation concept

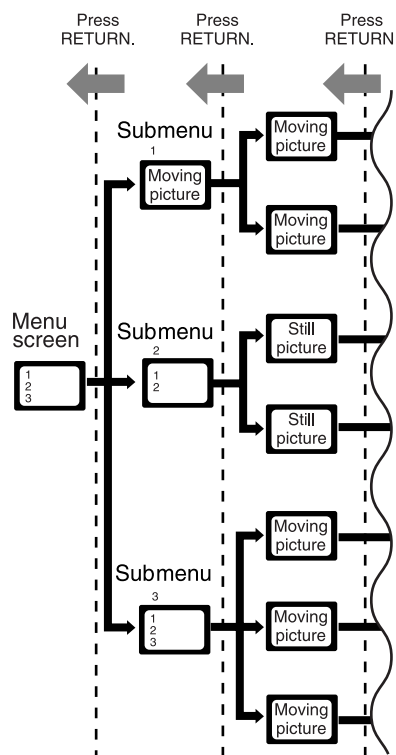

Selecting Playback Modes

Continued 

This unit cannot accept any disc operations while reading disc contents.

Programming the Playing Order of the Titles and Tracks—Program Play

You can arrange the order in which the titles (for DVD) and tracks (for SVCD, VCD and CD) play before you start playing. **You can program up to 18 steps.**

- When you use Program play for a SVCD or VCD with the PBC function activated, the PBC function is turned off.
- Program play cannot be used on some DVD discs.

On the unit:

- There is a time limit in doing the following steps. If the setting is canceled before you finish, start from step 2 again.

1 Load discs.

- If the current playing source is not the DVD/SVCD/VCD/CD player press DVD ►/||, then ■ before going to the next step.

2 Press PROGRAM so that “PROGRAM” appears on the display.



The PRGM (program) indicator also lights up on the display.



- If a program has been stored in memory, the program is called up.

3 Press one of the disc number buttons (DVD1, DVD2 or DVD3) you want to program.

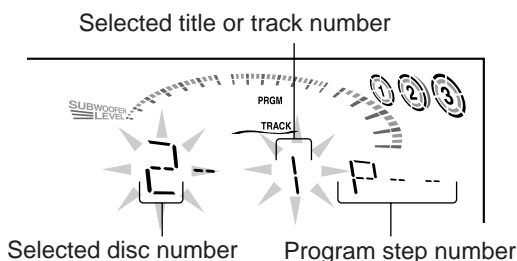

Ex.: When SVCD, VCD or CD is a source disc.

4 Turn ◀◀ / ▶▶ to select a title or track number, then press SET.

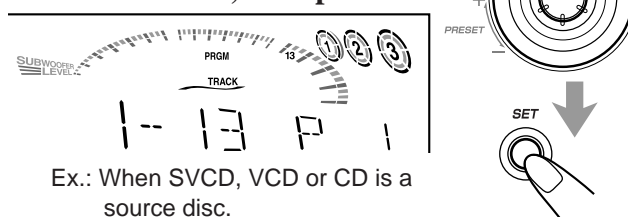

5 To program another title or track from the same disc, repeat step 4.

To program another title or track from a different disc, repeat steps 3 and 4.

- Each time you select a title or track, the program item is added up to 18 steps.

6 Press DVD ►/||.

The titles and tracks are played in the order you have programmed.

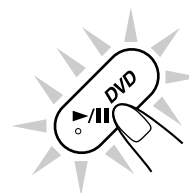

To stop playing, press ■.

To go to the next title or track, turn ◀◀ / ▶▶ to the right.



Even if you turn ◀◀ / ▶▶ to the left

It just goes back to the beginning of the current title or track, but cannot go back to the previous titles or tracks.

To modify the program

You can modify the program before or after playing.

To erase the last step, press CANCEL/DEMO.

- Each time you press the button, the last programmed step is erased from the program.



To add steps in the program before playing, simply select the disc number and title/track numbers you want to add by following steps 3 to 5 of the programming procedure.

To erase program completely, press ■ before or after playing.

The program you have made will be also erased,

- when you remove all the discs, and then press DVD ►/||.
- when you unplug the AC power cord.
- when a power failure occurs.

To exit from Program play mode, press PROGRAM after playing. The PRGM (program) indicator goes off. The program you have made is memorized.

To check the programed contents

Press PLAY MODE on the remote control. The programed contents appear on the TV screen.

To erase the play mode screen, press PLAY MODE again.

On the remote control:

1 Load discs.

- If the current playing source is not the DVD/SVCD/VCD/CD player press DVD ►, then ■ before going to the next step.

2 Press PLAY MODE.

The play mode screen appears on the TV.

3 Press CONTROL + or - to move ► to "PROGRAM," then press ENTER.

The program screen appears.

- If a program has been stored in memory, the program is called up.
- You cannot select "PROGRAM" during Random play.

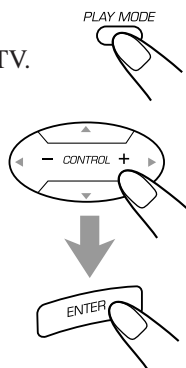

REPEAT	PROGRAM	RANDOM			
1	2	3	4	5	6
7	8	9	10	11	12
13	14	15	16	17	18

4 Press one of the disc number buttons (DVD 1, DVD 2 or DVD 3) you want to program while holding down SHIFT.

The selected disc number is shown on the TV screen.

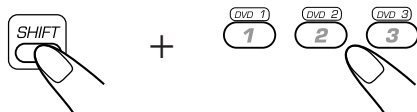

5 Press the number buttons to enter a title or track number you want to program.

The selected title or track number is shown on the TV screen.

Ex.: To select number 5, press 5.

To select number 10, press 10.

To select number 20, press +10 then 10.

To select number 23, press +10, +10 then 3.

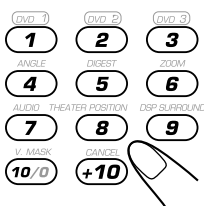
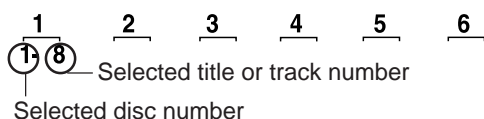

6 To program another title or track from the same disc, repeat step 5.

To program another title or track from a different disc, repeat steps 4 and 5.

- Each time you select a title or track, the program item is added up to 18 steps.

REPEAT	PROGRAM	RANDOM			
1-18	2-17	3-16	4-15	5-14	6-13
7	8	9	10	11	12
1-12	2-11	3-10	4-9	5-8	6-7
13	14	15	16	17	18
1-6	2-5	3-4	4-3	5-2	6-1

7 Press DVD ►.

The titles and tracks are played in the order you have programmed.



To stop playing, press ■.

To go to the next title or track, press ►►.



Even if you press ◀◀

It just goes back to the beginning of the current title or track, but cannot go back to the previous titles or tracks.

To modify the program

You can modify the program before or after playing.

To erase the last step, press CANCEL while holding down SHIFT.

- Each time you press the button, the last programmed step is erased from the program.

To add steps in the program before play, simply select the disc and title/track numbers you want to add by following steps 4 to 6 of the programming procedure.

To erase program completely, press CLEAR before or after playing.

The program you have made will be also erased,

- when you remove all the discs, and then press DVD ►.
- when you unplug the AC power cord.
- when a power failure occurs.

To exit from Program play mode, press PROGRAM on the unit after playing. The PRGM (program) indicator goes off. The program you have made is memorized.

To check the programed contents

Press PLAY MODE. The programed contents appear on the TV screen.

To erase the play mode screen, press PLAY MODE. The program you have made is memorized.

Playing at Random—Random Play

The titles and tracks of all loaded discs are played at random.

- When you use Random play for a SVCD or VCD with the PBC function activated, the PBC function is turned off.
- Random Play cannot be used on some DVD discs.

On the unit:

1 Load discs.

- If the current playing source is not the DVD/SVCD/VCD/CD player, press DVD ►/||, then ■ before going to the next step.

2 Press RANDOM so that “RANDOM” appears on the display.

The RANDOM indicator also lights up on the display.

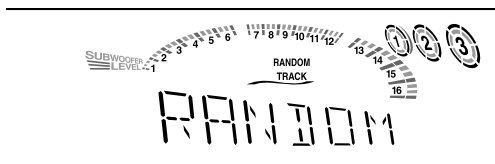

3 Press one of the disc number buttons (DVD1, DVD2 or DVD3) you want to play first.

The titles and tracks are played from the selected disc at random. Random play ends when all the titles and tracks on the all loaded discs are played once.

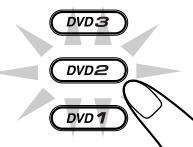

On the remote control:

1 Load discs.

2 Press one of the disc number buttons (DVD 1, DVD 2 or DVD 3) while holding down SHIFT to select the disc you want to play, then ■.

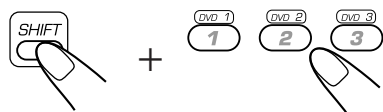

3 Press PLAY MODE.

The play mode screen appears on the TV.

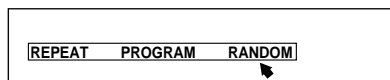

4 Press CONTROL + or - to move to “RANDOM,” then press ENTER.

The titles and tracks are played from the selected disc at random. Random play ends when all the titles and tracks on the all loaded discs are played once.

- You cannot select “RANDOM” during Program play.

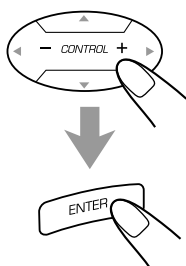

To stop playing, press ■.

- Random play also stops when the disc tray currently played is opened.

To exit from Random play mode when finished, press RANDOM on the unit. Or perform steps 3 and 4 on the remote control. Each time you press ENTER, the Random play turns on and off.

To skip the currently playing title or track, turn ◀◀ / ▶▶ to the right (or press ▶▶| on the remote control).

notes Even if you turn ◀◀ / ▶▶ to the left or press ◀◀ on the remote control

It just goes back to the beginning of the current title or track, but cannot go back to the previous titles or tracks.

To erase the play mode screen, press PLAY MODE.

Repeating Playback

Repeat Play

You can repeat a title, chapter or track.

- For DVD, to use Repeat play with Program play or Random play, select Repeat play after starting Program play or Random play .
- Repeat play cannot be used on some DVD discs.
- You can only use Repeat play on SVCD or VCD with the PBC function deactivated. When you turn on the PBC function after Repeat play, press REPEAT repeatedly until the REPEAT indicators go off from the display.

On the remote control:

1 Press PLAY MODE before or during play.

The play mode screen appears on the TV.



2 Press CONTROL + or - to move to “REPEAT.”

- When DVD is a playing source, “REPEAT” cannot be selected while playing.

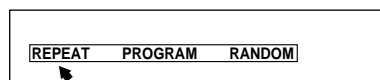
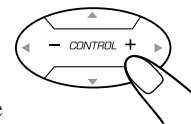

Ex.: When the playback is stopped.

3 Press ENTER repeatedly to select Repeat play mode you want.

- Each time you press the button, the Repeat play mode indication on the TV screen changes as follows:



When a DVD is a playing source.

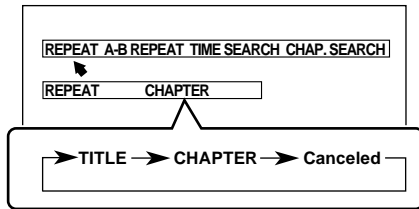

- **TITLE:** Current title will be repeated.
- **CHAPTER:** Current chapter will be repeated.

When a SVCD, VCD or CD is a playing source.

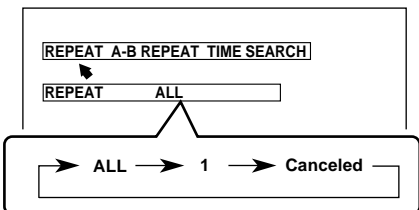

- **ALL:** All tracks on all discs will be repeated.
- **1:** Current track will be repeated.

To cancel Repeat play, perform steps 1 and 2, then press ENTER repeatedly until the REPEAT indications disappear from the TV screen.

To erase the play mode screen, press PLAY MODE.

On the unit:

Press REPEAT before or during play.

The REPEAT indicators also light up on the display.

- Each time you press the button, Repeat play mode changes as follows:



For DVD

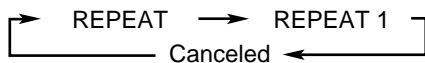

- REPEAT:** Current chapter will be repeated.
- REPEAT 1:** Current title will be repeated.

For SVCD, VCD and CD

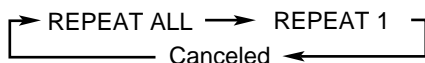

- REPEAT ALL:** All tracks on all discs will be repeated.
- REPEAT 1:** Current track will be repeated.

To cancel Repeat play, press REPEAT repeatedly until the REPEAT indicators go off from the display.

A-B Repeat

While playing, you can also select a portion you want to repeat.

- During Program play, Random play or Repeat play A-B Repeat play cannot be selected.
- A-B Repeat is not performed between different chapters or different titles on a DVD.

On the remote control ONLY:

1 Press PLAY MODE during play.
The play mode screen appears on the TV.



2 Press CONTROL + or - to move to "A-B REPEAT."

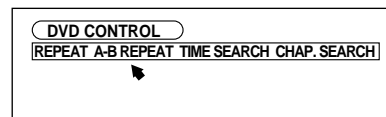
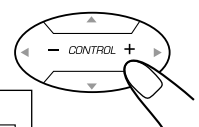

Ex.: When DVD is a playing source.

3 Press ENTER at the starting point you want to repeat (point A).



The A-B Repeat indication appears on the TV screen.

A 1:12:34 → B -: -: -

4 Press ENTER again at the end point you want to repeat (point B).

A-B Repeat begins.

The unit automatically locates point A and starts repeated playback of the portion between points A and B.

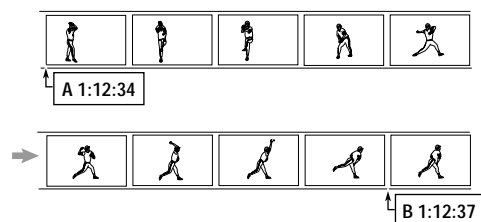

To cancel A-B Repeat play, press ENTER. A-B Repeat play is canceled and normal playback starts.

To erase the play mode screen, press PLAY MODE.

Still Picture/Frame-by-Frame Playback

You can still a picture and advance the still picture frame by frame.

Still picture

On the remote control ONLY:

Press **II** once during play.

A still picture appears on the TV screen.

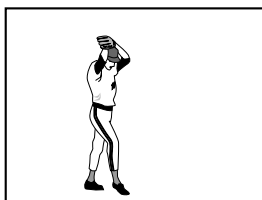

Frame-by-frame playback

On the remote control ONLY:

Press **II** repeatedly during play to advance the picture frame by frame.

- Each time you press the button, the picture advances frame by frame.



To go back to normal play, press DVD .

Viewing Continuous Still Pictures—Strobe

You can view 9 continuous still pictures.

On the remote control ONLY:

1 Press **II** during play at the point you want to view continuous still pictures.

A still picture appears on the TV screen.

2 Press and hold **STROBE** for more than 1 second.

9 continuous still pictures appear on the TV screen.

- Pressing **STROBE** again, next 9 still pictures appear.



To cancel strobe play, press and hold **STROBE**. A still picture appears. Then press DVD  to go back to normal play.



If you press and hold **STROBE** for more than 1 second during normal playback

9 pictures also appear but advance at normal speed.

Slow Motion Playback—Slow

You can enjoy slow motion playback.

- Reverse slow motion playback cannot be used on some SVCDs or VCDs.

On the remote control ONLY:

1 Press **II** once during play.

A still picture appears on the TV screen.



2 Press **SLOW +** or **-** to start slow motion playback.

- Each time you press **SLOW +**, forward slow motion speed changes as follows:

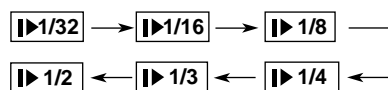

- Each time you press **SLOW -**, reverse slow motion speed changes as follows:

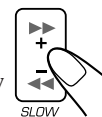
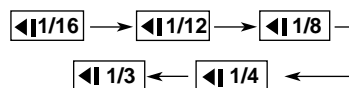

No sound is heard during slow motion playback.

To go back to normal play, press DVD .

Zoom in the Picture—Zoom

You can zoom a picture by 2 times.

On the remote control ONLY:

1 Press **ZOOM** while holding down **SHIFT** during play.

“ZOOM” appears on the TV screen.

- Each time you press **ZOOM** while holding down **SHIFT**, the picture is zoomed in and out alternately.

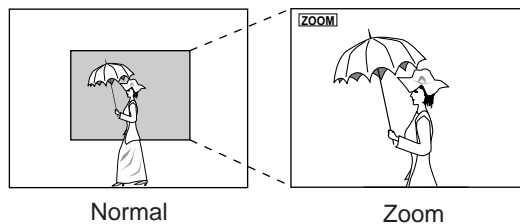
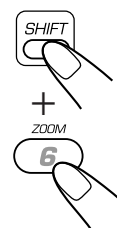

Normal

Zoom

2 Press **Cursor** (/ / /) to select the position you want to zoom in.

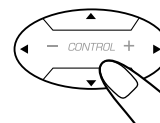

To go back to normal play, press **ZOOM** while holding down **SHIFT**.

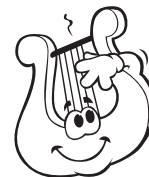

Viewing the Desired Chapters/Tracks—Digest

You can view 9 opening scenes of chapters or tracks at a time and select desired scene from those displayed on the TV screen directly.

- You cannot use this function on SVCD or VCD with the PBC function.

On the remote control ONLY:

1 Press DIGEST while holding down SHIFT when the disc is stopped playing or during play back.

The opening scene appears in sequence (up to 9 pictures at a time) on the TV screen.

- When DVD is a source disc and stopped, the opening scene of each title appears.
- When DVD is a source disc and played back, the opening scene of each chapter in the current title appears.
- When SVCD or VCD without the PBC function is loaded, the opening scene of each track appears.

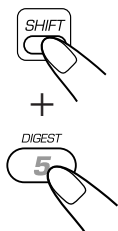

2 Press Cursor (▲ / ▼ / ► / ◀) to move to a scene you want to start play back.

- If there are more than 9 scenes, you can see next 9 scenes. To go to the next screen press NEXT, and to go back to the previous screen press PREV.

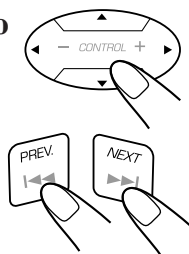

3 Press SELECT or ENTER.

Playback starts from the selected scene.

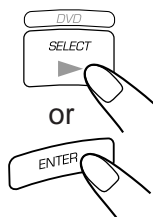

Selecting the Picture Brightness—Theater Position

You can select picture brightness from among three options according to the source program, lighting condition of the room and/or personal preference.

On the unit:

Press THEATER POSITION during play.

On the remote control:

Press THEATER POSITION while holding down SHIFT during play.

The theater position indication appears on the TV screen.

- Each time you press THEATER POSITION, the theater position changes as follows. The picture brightness becomes darker as the number increases.

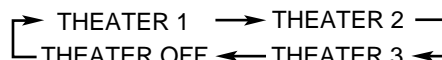
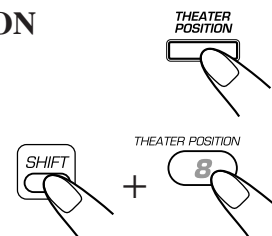

To cancel the function, select “THEATER OFF.”

Playing Back Tapes

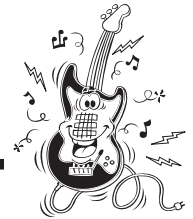

You can play back type I, type II, and type IV tapes without changing any settings.

Playing Back a Tape

1 Press EJECT (▲) for the deck you want to use.

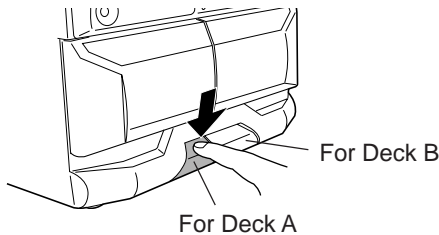

2 Put a cassette in with the exposed part of the tape down.

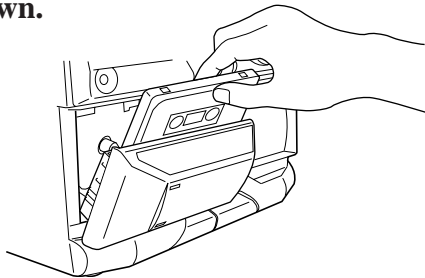

3 Close the cassette holder gently.

If you put cassettes in both decks A and B, the last deck you have closed is selected.

To operate the other deck, press TAPE A/B (or press TAPE A/B while holding SHIFT on the remote control).

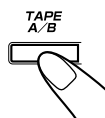

4 Press TAPE ◀▶.

The tape play starts and the tape direction indicator (▶ or ◀) on the display starts flashing slowly to indicate the tape running direction.

- Each time you press the button, the tape direction changes.

- ▶ : plays the front side.

- ◀ : plays the reverse side.

- If no cassette is inserted, “NO TAPE” appears on the display.

When the tape plays to the end, the deck automatically stops if the Reverse Mode is off. (See “To play both sides repeatedly—Reverse Mode.”)



To stop playing, press ■.

To fast-wind to the right or to the left, press ▶▶ or ◀◀ while the tape is not running.

The tape direction indicator (▶ or ◀) starts flashing quickly on the display.

To remove the cassette, press ▲ EJECT for deck A or EJECT ▲ for deck B.

To play both sides repeatedly—Reverse Mode

Reverse Mode works for both decks at the same time.

When it is in use, the tape automatically reverses at the end of a side and the unit starts playing for the other side of the tape, and repeats the same process.

To use Reverse Mode, press

REVERSE MODE so that the Reverse Mode indicator on the display lights up like—(↔).

To cancel Reverse Mode, press the button again so that the Reverse Mode indicator on the display lights up like—↔.



When Reverse Mode is on with cassettes in both decks A and B

After the reverse (◀) side of the tape finishes playing, the tape in the other deck starts playing.

Locating the Beginning of a Song —Music Scan

You can use Music Scan to locate the beginning of a song.

Music Scan searches for blank portions that usually separate recorded songs, then plays the next song.

To find the beginning of the current song

During play, press ▶▶ or ◀◀ in the **opposite direction** to the tape play.

The tape direction indicator of the opposite direction to the tape play starts flashing slowly.

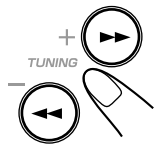

Searching stops automatically at the beginning of the current song, and the current song starts automatically.

To find the beginning of the next song

During play, press ▶▶ or ◀◀ in the **same direction** as the tape play.

The tape direction indicator of the same direction as the tape play starts flashing slowly and quickly alternately.

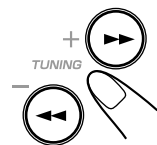

Searching stops automatically at the beginning of the next song, and the next song starts automatically.



Music Scan works by detecting a 4-second long blank between each song, so it will not work well in the following cases

- No blank at the beginning of a song.
- Noise (often caused by much use or poor quality dubbing) which fills the blank.
- Long, very soft passages or pauses in a song.



The use of the C-120 or thinner tape is not recommended, since characteristic deterioration may occur and this tape easily jams in the pinch-rollers and the capstans.

Using DSP Surround Mode



In order to reproduce a more acoustic sound field in your listening room while playing any source, you can use following DSP Surround modes.

- DSP Surround mode can be also used for a disc encoded with Dolby Digital 5.1ch or with MPEG Multichannel.

You can select one of the following DSP Surround modes according to your preference.

S (Small) THEATER:	Reproduces the sound field of a small theater (where the seating capacity about 300).
L (Large) THEATER:	Reproduces the sound field of a large theater (where the seating capacity about 1,000).
LIVECLUB:	Gives the feeling of a live music club with a low ceiling.
PAVILION:	Gives the spacious feeling of a pavilion with a high ceiling.
CHURCH:	Gives the spacious feeling of a majestic church with a high ceiling.

Activating and Adjusting the DSP Surround Mode

You can use the DSP Surround mode for any source you like.

On the remote control:

Only when using the remote control, you can adjust the delay time of the surround speakers.

1 Press DSP SURROUND, while holding down SHIFT, to select a desired DSP Surround mode.

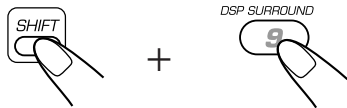

- Each time you press the button, the DSP Surround mode changes as follows:

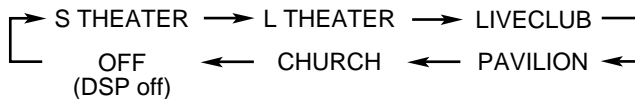

- When one of the DSP Surround modes is activated, the SURROUND lamp on the unit lights up.

2 Press LEVEL SELECT repeatedly until “DELAY” appears on the display.



3 Press LEVEL + / - to adjust the delay time.

- Each time you press the button, the delay time changes as follows:

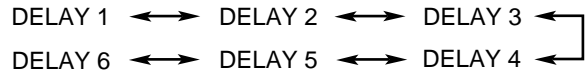
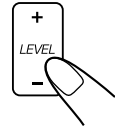

As the number increases, the delay time increases so that you can obtain much larger sound field.

- This setting does not affect the delay time setting of the “SPEAKER SETTING.” (See page 40.)

To cancel the DSP Surround mode, select “OFF” in step 1 so that the SURROUND lamp goes off.

On the unit:

When using the buttons on the unit, you can activate the DSP Surround modes, but cannot make delay time adjustment.

Press DSP SURROUND > or < to select a desired DSP Surround mode.

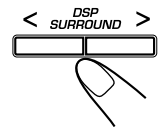

- Each time you press the button, the DSP Surround mode changes as follows:

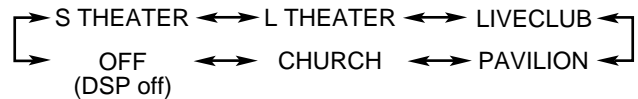

- When one of the DSP Surround modes is activated, the SURROUND lamp on the unit lights up.

To cancel the DSP Surround mode, select “OFF” so that the SURROUND lamp goes off.



When you use one of sound modes with surround elements—D.CLUB, HALL, STADIUM (see page 13)

You can set these sound modes together with the DSP Surround modes, but the surround elements of these sound modes are changed to the DSP Surround mode.

IMPORTANT:

- It may be unlawful to record or playback copyrighted material without the consent of the copyright owner.
- The recording level is automatically set correctly, so it is not affected by the VOLUME, the SUBWOOFER LEVEL, the SOUND MODE, and the DSP Surround controls. Thus, during recording you can adjust the sound you are actually listening to without affecting the recording level.
- If recordings you have made have excessive noise or static, the unit may be too close to a TV. Increase the distance between the TV and the unit.
- You can use type I tape for recording.

To protect your recording

Cassettes have two small tabs on the top to protect from unexpected erasure or re-recording.

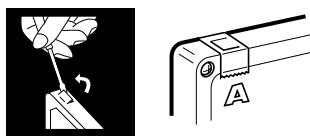

To protect your recording, remove these tabs.

To re-record on a protected tape, cover the holes with adhesive tape.

To keep the best recording and playback sound quality

If the heads, capstans, and pinch rollers of the cassette decks become dirty, the following will occur:

- Impaired sound quality
- Discontinuous sound
- Fading
- Incomplete erasure
- Difficulty in recording

To clean the heads, capstans, and pinch rollers

Use a cotton swab moistened with alcohol.

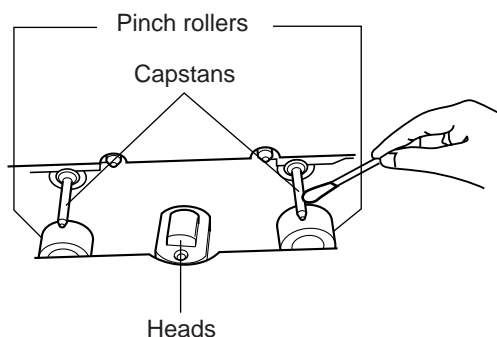

To demagnetize the heads

Turn off the unit, and use a head demagnetizer (available at electronics and audio shops).

Recording a Tape on Deck B

On the unit ONLY:

1 Press EJECT ▲ for the deck B.

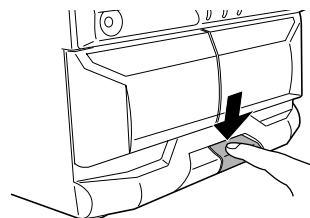

2 Put a recordable cassette into deck B.

3 Close the cassette holder gently.

4 Start playing the source—FM, AM, DVD/SVCD/VCD/CD player, deck A, or auxiliary equipment connected to AUX jacks.

- When the source is SVCD, VCD or CD, you can also use SVCD/VCD/CD Direct Recording (see page 33) and Auto Edit Recording (see page 34).
- When the source is deck A, you can also use the dubbing method. (See “Dubbing Tapes” on page 33.)

5 Check the tape direction of deck B.

- If the tape direction is not correct, press TAPE ◀▶ twice then ■ to change the tape direction.

6 Press REC START/STOP.

The REC (recording) indicator lights up on the display and recording starts.

- If no cassette is inserted, “NO TAPE” appears on the display. If a protected tape is inserted, “NO REC” appears on the display.



To stop recording immediately, press ■.

To remove the cassette, press EJECT ▲ for deck B.

To record on both sides—Reverse Mode

Press REVERSE MODE so that the Reverse Mode indicator lights up like—(↔).

- When using the Reverse Mode for recording, start recording in the forward (▶) direction first. Otherwise, recording will stop when recording is done only on one side (reverse) of the tape.



To cancel Reverse Mode, press the button again so that the Reverse Mode indicator lights up like—↔.

Dubbing Tapes

You can record from one tape to another.

On the unit ONLY:

1 Press **TAPE** ◀▶, then ■.

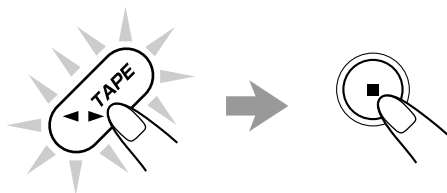

2 Put the source cassette in deck A, and a recordable cassette in deck B.

- Put the cassettes in both decks so that the tapes will run in the forward (▶) direction.

3 Press **DUBBING**.

The **REC** (recording) indicator lights up on the display and dubbing starts.



To stop dubbing, press ■ so that both decks (A and B) stop.

To record on both sides—Reverse Mode

Press **REVERSE MODE** so that the Reverse Mode indicator lights up like—(↔).



To cancel Reverse Mode, press the button again so that the Reverse Mode indicator lights up like—↔.

SVCD/VCD/CD Direct Recording

You can easily record sound of a SVCD or VCD without the PBC function or CD onto a tape.

- You can also record the tracks in order you have made the program.
- This function cannot be used for recording DVDs.

On the unit ONLY:

1 Put a recordable cassette into deck B.

2 Load discs with the label side up.

3 Press one of the disc number buttons (**DVD1**, **DVD2**, or **DVD3**) to select the disc, then ■.



4 Press **CD REC START**.

“CD REC” appears, and the **REC** (recording) indicator lights up on the display.

Deck B starts recording and the DVD/SVCD/VCD/CD player starts playing.

When the recording is done, “CD REC FINISHED” appears on the display, and the DVD/SVCD/VCD/CD player and deck B stop.



To stop recording, press **REC START/STOP** or ■ so that a 4-second blank portion is created on the recording tape. (Remember a 4-second blank is important when using Music Scan—see page 30.)



To record on both sides—Reverse Mode

Press **REVERSE MODE** so that the Reverse Mode indicator lights up like—(↔).



- When using the Reverse Mode for SVCD/VCD/CD Direct Recording, start recording in the forward (▶) direction first. When the tape reaches its end while recording a song in the forward direction (▶), the last song will be re-recorded at the beginning of the reverse side (◀).

If you start recording on the reverse side (◀), recording will stop when recording is done only on one side (reverse) of the tape.

To cancel Reverse Mode, press the button again so that the Reverse Mode indicator lights up like—↔.



Auto Edit Recording

By using Auto Edit Recording, you can record disc tracks to fit the tape. Auto Edit Recording makes a program by selecting disc tracks in numerical order. However, to prevent the end of the last track on the front side from being cut off, the last track is selected so as to fit on the remaining tape length.

- This function cannot be used for recording DVD, SVCD and VCD.

On the unit ONLY:

1 Load discs with the label side up.

2 Press EDIT.

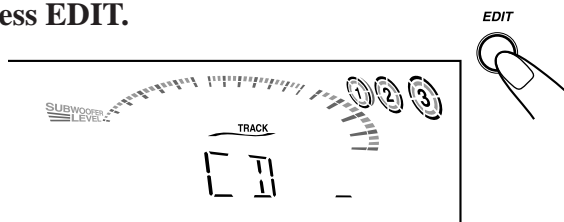

3 Press the disc number button (DVD1, DVD2, or DVD3) for the disc you want to record from.

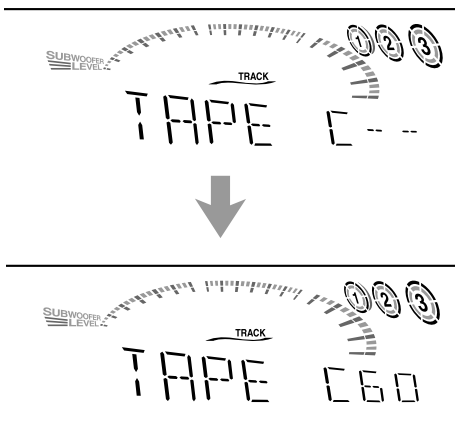

The optimum tape length for the disc appears.

To change the tape length manually

If the tape length selected is not satisfactory, you can change the tape length by turning ◀◀ / ▶▶.

You can select the tape length among the following — 40, 46, 50, 54, 60, 64, 70, 74, 80, 84, and 90.

4 Press SET.

- Each time you press the button, the tracks to be recorded on the front side (“SIDE-A”) and on the reverse side (“SIDE-B”) alternate.

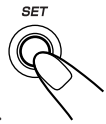

Tracks to be recorded on the reverse side (SIDE-B) appear.

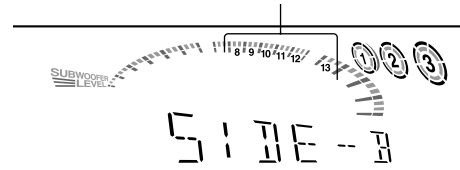

5 Put a recordable cassette of appropriate length into deck B.

6 Press REVERSE MODE so that the Reverse Mode indicator lights up like (↔).

- Without turning on the Reverse Mode (↔), recording will stop when the front side of the tape is recorded.

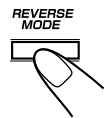

7 Press CD REC START.

“TAPE SIDE-A STAND-BY” appears, and the REC (recording) indicator lights up on the display.

Deck B starts recording then, and about 10 seconds later, the DVD/SVCD/VCD/CD player starts playing.

When the recording is done, “CD REC FINISHED” appears on the display, and the DVD/SVCD/VCD/CD player and deck B stop.

- If a tape has not been rewound, deck B will rewind the tape before it starts recording.
- A 10-second blank portion is automatically created at the beginning of each side of the tape.



To stop recording, press REC START/STOP or ■ so that a 4-second blank portion is created on the recording tape. (Remember a 4-second blank is important when using Music Scan—see page 30.)

To cancel Auto Edit Recording

Press CANCEL/DEMO or ■ before or after recording.

Using the Microphones

You can enjoy singing along (Karaoke) and microphone mixing by using two microphones.

- MIC LEVEL adjustment is valid for both microphones connected to the MIC 1 and MIC 2 jacks.

IMPORTANT:

- Always set MIC LEVEL to MIN when connecting or disconnecting the microphone.
- When you do not use the microphone, keep it microphones unconnected.

DO NOT forget to cancel the Karaoke mode by pressing V. MASK while holding SHIFT after you finish enjoying Karaoke. Otherwise normal playback cannot be started.

Singing along (Karaoke)

Vocal Masking

Vocal Masking reduces the lead vocal of any playing source, and allows you to replace it by singing into the microphones as the music plays.

- Vocal Masking continues to function even though you change the source.

1 Turn MIC LEVEL to MIN.

2 Connect the microphone(s) (not supplied) by plugging it into the MIC 1 and/or MIC 2 jack.

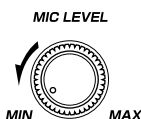

3 Press V. MASK while holding down SHIFT on the remote control.

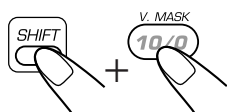

The karaoke (🎤) indicator lights up on the display.

4 Start playing the source—DVD/SVCD/VCD/CD player, tape, FM/AM tuner or other connected component.

5 Turn MIC LEVEL and VOLUME as you sing into the microphone(s).

- By pressing REC START/STOP, you can record your singing along if you want. (See page 32.)

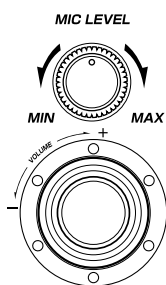

To apply an echo to your voice

You can apply echo effect to your voice.

On the remote control ONLY:

Press ECHO while holding down SHIFT.

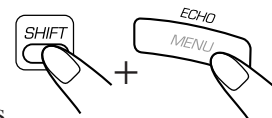

- Each time you press the buttons, the echo level changes as follows. As the number increases, a stronger echo effect applies to your voice.

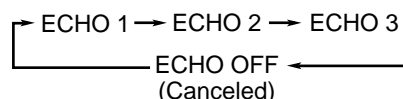

To adjust the Key

You can adjust the key of the disc to fit to your voice.

- This function is available while playing back discs loaded on the DVD/SVCD/VCD/CD player.

On the remote control ONLY:

Press KEY CONTROL # or b while holding down SHIFT to adjust the key.

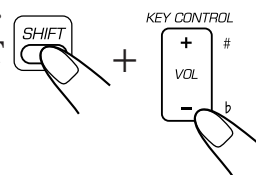

The following display appears.

Adjustable key range is “-6” to “6.”

KEYCON 0

- To raise the key, press KEY CONTROL #.
- To lower the key, press KEY CONTROL b.

You can also check your key adjustment on the TV screen.

To cancel the key control, set the key to “KEYCON 0” by pressing KEY CONTROL # or b.



When the current playing title or track finishes the key returns to “KEYCON 0.”

notes If howling or squealing (feedback) occurs while using the microphone(s)

Take the following actions to prevent these noises.

- Adjust MIC LEVEL and VOLUME.
- Avoid pointing the microphone(s) towards the speakers.
- When two microphones are connected, turn off the unused microphone.

notes If you use the following sources as the playing source for Karaoke (Vocal Masking), you cannot get the satisfactory results

- Radio programs—a radio signal is not as reliable as the signals coming from a tape or disc.
- Monaural sources.
- Poorly dubbed tapes.
- Sources recorded with duets, strong echo, a chorus, or only a few instruments.

Microphone mixing

- 1 Connect the microphone(s).**
- 2 Start playing the source—DVD/SVCD/VCD/CD player, tape, FM/AM tuner or other connected component.**
- 3 Turn MIC LEVEL and VOLUME as you sing into the microphone(s).**

- By pressing REC START/STOP, you can record your singing along if you want. (See page 32.)

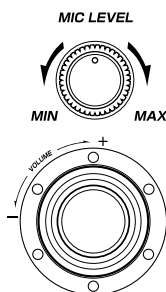

notes If the playing disc is a multiplex Karaoke disc
 You can enjoy multiplex sound by pressing AUDIO on the remote control while holding down SHIFT. (See page 18.) You can also replace the vocal part with your voice by selecting instrument sound on DVD, SVCD or VCD.

To use microphone only
 Without any background sound, you can use your microphone(s), and record it if you want.

- 1 Connect the microphone(s).**
- 2 Press DVD ►/II (or DVD ► on the remote control), then ■.**

No background sound will be heard.

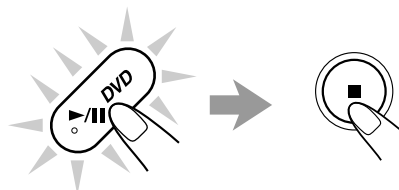

- 3 Turn MIC LEVEL and VOLUME as you sing into the microphone(s).**

- By pressing REC START/STOP, you can record your singing along if you want. (See page 32.)

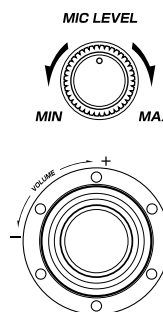

Reserving Karaoke Songs —Karaoke Program Play

You can determine the playback order of the titles or tracks on the DVD/SVCD/VCD/CD player. **You can program up to 12 steps.**

- You cannot use reserve function when a SVCD or VCD with the PBC function is played back. Press ■ before performing below procedure.
- When playing back a DVD, you can only reserve titles on the disc.

On the remote control ONLY:

1 Press RESERVE while holding down SHIFT.

The karaoke reserve screen appears on the TV.

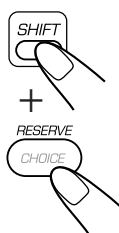
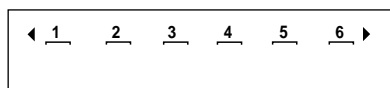

2 Press one of the disc number buttons (DVD 1, DVD 2 or DVD 3) you want to program while holding down SHIFT.

The selected disc number is shown on the TV screen.

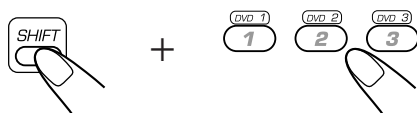

3 Press the number buttons to enter a title or track number you want to program.

The selected title or track number is shown on the TV screen.

- Ex.: To select number 5, press 5.
 To select number 10, press 10.
 To select number 20, press +10 then 10.
 To select number 23, press +10, +10 then 3.

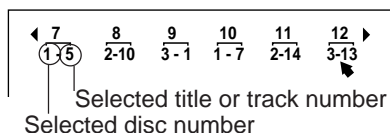

- PRGM indicator also flashes on the display.

4 To program another title or track from the same disc, repeat step 3.

To program another title or track from a different disc, repeat steps 2 and 3.

Each time you select a title or track, the program item is added up to 12 steps.

5 Press V. MASK while holding down SHIFT.

The karaoke (🎤) indicator lights up on the display.

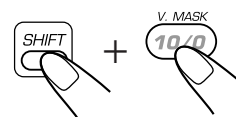

6 Press DVD ►.

The titles and tracks are played in the order you have programmed.

- A title or track which has finished played back is deleted from the reserved program.



The play is stops after playing back all reserved program and the PRGM indicator goes from the display.

To modify the program

You can modify the program before or after playing.

To erase a reserved steps, press CANCEL while holding down SHIFT.

- Each time you press the buttons, the last programmed step is erased from the program.

To add steps in the reserve program before playing, press Cursor ► or ◀ to move to a number you like to add, then select the disc and title/track numbers by following steps 2 and 3 before or after playing.

To erase program completely before playing, press CLEAR when the playback is stopped.

The program you have made will be also erased,

- when you remove all the discs, and then press DVD ►.
- when you unplug the AC power cord.
- when a power failure occurs.

To check the programmed contents

Press RESERVE while holding down SHIFT. The programmed contents appear on the TV screen.

To erase the karaoke reserve screen, press RESERVE while holding down SHIFT again. The program you have made is modified.

To exit from Karaoke Program play mode, press ■ and then PROGRAM on the unit twice.





If you do not press DVD ► in step 6, The normal play continues.

Using the on-screen menus, you can store the initial selection for subtitle languages and audio languages (sound) for DVD playback as well as other settings.

- The on-screen menu disappears if no operation is done for five minutes.

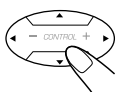
Buttons you use to operate on-screen menus (on the remote control)

	<ul style="list-style-type: none"> • Press to show or erase the on-screen menu.
	<ul style="list-style-type: none"> • Press to select the item.
	<ul style="list-style-type: none"> • Press to enter into sub-menu. • Press to enter your selection.

On-screen menus

- **LANGUAGE menu** (see page 39)

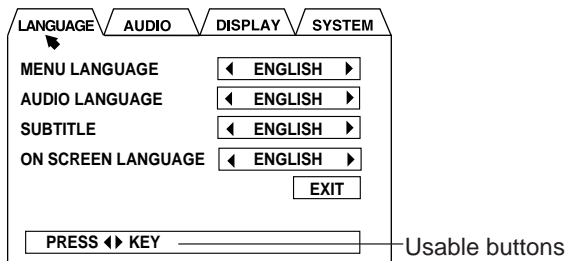

- **AUDIO menu** (see page 39)

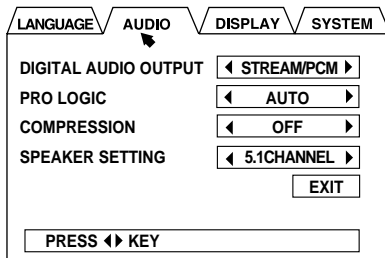

- **DISPLAY menu** (see page 41)

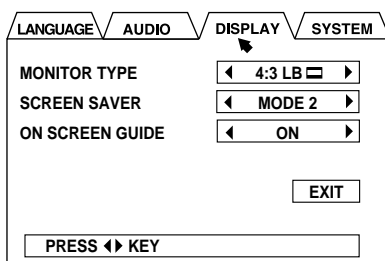

- **SYSTEM menu** (see page 42)

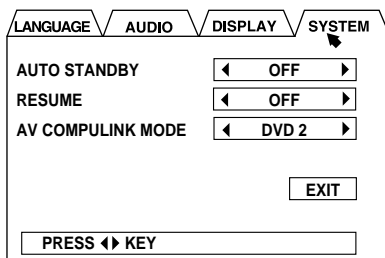

Basic Procedure

The on-screen menu appears only when the selected source is DVD, SVCD or VCD on the DVD/SVCD/VCD/CD player and the disc is not played back.

On the remote control ONLY:

1 Press CHOICE.

LANGUAGE menu appears.

2 Press Cursor > or < to move to the menu you want—LANGUAGE, AUDIO, DISPLAY, or SYSTEM.

Selected item changes its color to green.

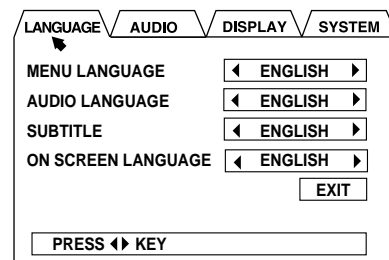

Ex.: When selecting LANGUAGE menu.

3 Press Cursor < or > to move to an item you want to set.

Selected item changes its color to green.

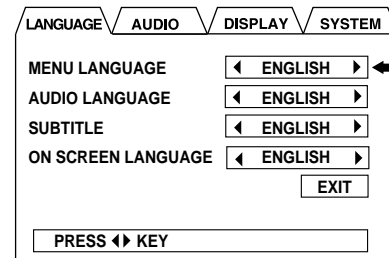

Ex.: When selecting "MENU LANGUAGE."

4 Press Cursor > or < to select a proper setting you want.

- When selecting "EXPERT" for "SPEAKER SETTING" on AUDIO menu, press ENTER. (See page 39.)

5 To set the other items on the same menu, repeat steps 3 and 4.

To set the other items on the different menus, repeat steps 2 to 4.

6 When finished, press Cursor < to move to "EXIT," then press ENTER.

The on-screen menu disappears.

To exit from the on-screen menu any time during the above procedure, press CHOICE. The settings you have done by that time will be stored.

Changing the Initial Language Settings

On LANGUAGE menu, you can select the following initial languages.

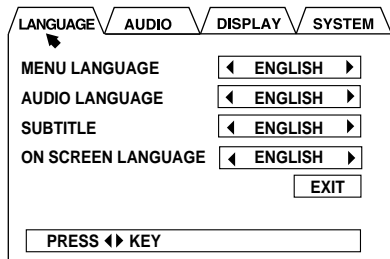

- **MENU LANGUAGE** :Select the DVD menu language.
Selectable languages—ENGLISH, SPANISH, FRENCH, CHINESE, GERMAN, ITALIAN, JAPANESE, AA – ZU (Language code: see page 52.)
- **AUDIO LANGUAGE** :Select the initial language for audio sound language.
Selectable languages—ENGLISH, SPANISH, FRENCH, CHINESE, GERMAN, ITALIAN, JAPANESE, AA – ZU (Language code: see page 52.)
- **SUBTITLE** :Select the initial language for subtitles.
Selectable languages—ENGLISH, SPANISH, FRENCH, CHINESE, GERMAN, ITALIAN, JAPANESE, AA – ZU (Language code: see page 52.)
- **ON SCREEN LANGUAGE** :
Select the language for the on-screen menus and indications.
Selectable languages—ENGLISH, 中国語 (Chinese), ESPAÑOL (Spanish)

NOTICE: The original language will be selected as the initial language regardless of your setting in the following cases.

- If the language you have selected is not recorded on the disc.
- If the disc is programed to be played back in the original language.

Changing the Various Audio Settings

On AUDIO menu, you can change the following sound settings.

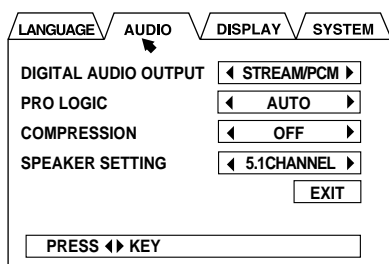

• DIGITAL AUDIO OUTPUT :

Set the output signal type through the OPTICAL DIGITAL OUTPUT terminal. (For the output signal types, see page 51.)

- Select “**STREAM/PCM**” when connecting an amplifier or a decoder compatible with DTS, Dolby Digital and MPEG Multichannel.
- Select “**PCM ONLY**” when connecting a digital recording device such an MD recorder, DAT deck, etc.
- Select “**DOLBY DIGITAL/PCM**” when connecting an amplifier or a decoder compatible only with Dolby Digital.

• PRO LOGIC :

Set the output signal type.

- Select “**AUTO**” to output original signals recorded in discs.
- Select “**ON**” to automatically decode into Pro Logic format. You cannot use this setting for a DVD with Linear PCM.
- Select “**OFF**” to down mix multichannel source to the front left and the front right.
By selecting “OFF,” you can enjoy full range stereo sound when using headphones, hearing through AUX OUT jacks, and recording.
- The PRO LOGIC lamp on the front panel lights up when—
 - setting “PRO LOGIC” to “ON” when playing back any disc except Dolby Digital 5.1ch and MPEG Multichannel discs.
 - setting “PRO LOGIC” to “AUTO” when playing back a Dolby Surround Pro Logic disc.

When playing back a CD, set this item to “AUTO” or “OFF.” You cannot show the on-screen menu when CD is the playing source. Show the on-screen menu by selecting a DVD, SVCD or VCD as a playing source or remaining the disc tray opened, and change the setting.

• COMPRESSION :

Compress the dynamic range (difference between the maximum and minimum sound levels) while playing a source encoded with Dolby Digital. This is useful when listening at a low volume level.

- Select “**ON**” to apply dynamic compression.
- Select “**OFF**” not to apply dynamic compression (full dynamic range recorded on the original disc.)

• SPEAKER SETTING :

Set the speaker’s output level and delay time according to your speaker setting in your listening room. (See page 40.)

- Select “**5.1CHANNEL**” if all the speakers are located at the same distance from the listening position.
- Select “**EXPERT**” if you cannot locate all the speakers at the same distance from the listening position. Select “EXPERT” to enter EXPERT SPEAKER SETTING menu, then press ENTER.

More about "SPEAKER SETTING"

The following example shows the ideal speaker locations for surround reproduction in your listening room.

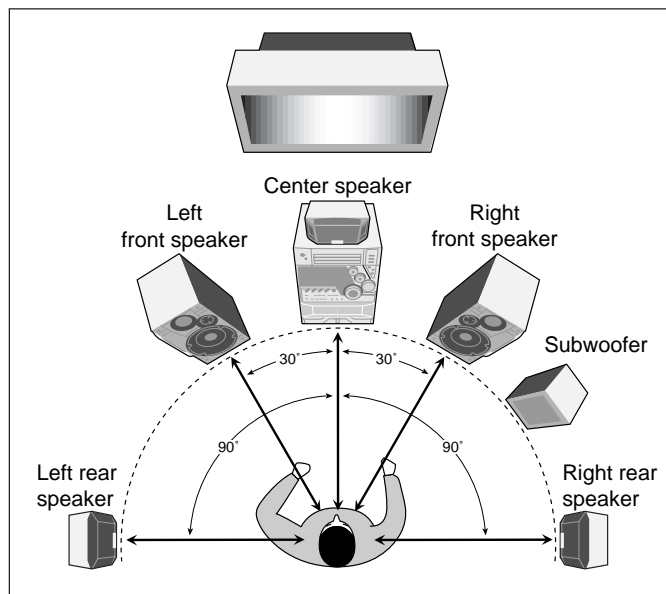

If you can locate the speakers as the above example, you can select "5.1CHANNEL" for your speaker setting.

If you can NOT do as above, select "EXPERT," then press ENTER. EXPERT SPEAKER SETTING menu appears and you can adjust the output level and delay time for the center and rear speakers.

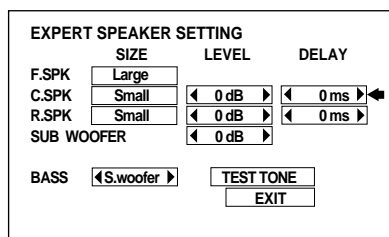

- You cannot adjust the speaker size (SIZE) settings.

On EXPERT SPEAKER SETTING menu, you can set the following:

- **C.SPK-LEVEL:** Adjust the output level for the center speaker. (See page 41.)
- **R.SPK-LEVEL:** Adjust the output level for the rear speakers. (See page 41.)
- **SUB WOOFER-LEVEL:** Adjust the output level for the subwoofer. (See page 41.)
- **C.SPK-DELAY:** Adjust the delay time for the center speaker. (See the right.)
- **R.SPK-DELAY:** Adjust the delay time for the rear speakers. (See the right.)
- **BASS:** Select the speaker for bass output. (See page 41.)

"EXPERT" adjustment procedure

■ Adjusting the delay time for the center and rear speakers

You can adjust the delay time of the sounds from the center speaker and from the rear speakers, comparing to that of the sound from the front speakers.

If the distance to the center speaker and/or rear speakers from your listening position is almost the same as that to the front speakers, select "0 ms" (the default setting for "5.1CHANNEL" settings).

- 1 msec increase (or decrease) in delay time corresponds to 1 foot (30 cm) increase (or decrease) in distance.

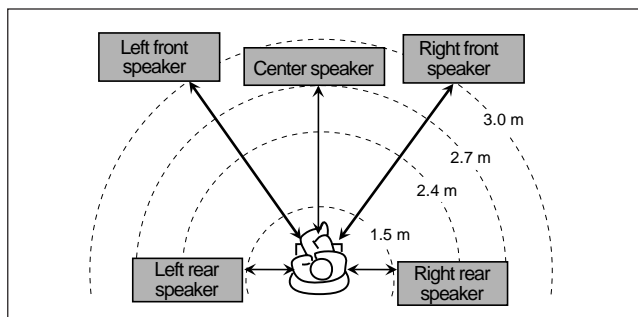

Ex.: In this case, set "C.SPK-DELAY" to "-1 ms" and "R.SPK-DELAY" to "-5 ms."

1 Display EXPERT SPEAKER SETTING menu.

- See page 38.

2 Press Cursor (▲ / ▼ / ► / ◀) to move ◀ to "C.SPK-DELAY," then press ENTER.

3 Press Cursor ► or ◀ to select "-1 ms," then press ENTER.

- Adjustable range for the center speaker delay time is from "-5 ms" to "0 ms."

4 Press Cursor ▼ or ▲ to move ◀ to "R.SPK-DELAY," then press ENTER.

5 Press Cursor ► or ◀ to select "-5 ms," then press ENTER.

- Adjustable delay time for rear speakers is "-5 ms," "-10 ms" and "-15 ms."

Now you can also adjust the speaker output level and select the speaker for the bass output (see next page).

6 When finished, press Cursor (▲ / ▼ / ► / ◀) to move ◀ to "EXIT," then press ENTER.

EXPERT SPEAKER SETTING menu disappears.

■ **Adjusting the center and rear speaker output levels**
 You can adjust the speaker output level for the center speaker and rear speakers.

You can adjust the output level while listening to the test tone.

- Make adjustments so that the sound level of the selected speaker is set at the same level as that of the front speakers.
- To output test tone properly, turn off the sound mode and the DSP Surround mode before entering on-screen menu.

1 Display EXPERT SPEAKER SETTING menu.

- See page 38.

2 Press Cursor (▲ / ▼ / ► / ◄) to move ◀ to “TEST TONE,” then press ENTER.

“TEST TONE” changes its color to green and test tone comes out of in the following sequence—left front speaker, center speaker, right front speaker, right rear speaker, and left rear speaker.

- Test tone is output only when the tray loaded with a DVD is selected.

3 Press Cursor (▲ / ▼ / ► / ◄) to move ◀ to “C.SPK-LEVEL” or “R.SPK-LEVEL,” then press ENTER.

4 Press Cursor ► or ◄ to adjust the output level, then press ENTER.

- You can adjust the output level from “-6 dB” to “+6 dB.”

5 Repeat steps 3 and 4 to adjust the other speaker output level.

6 Press Cursor (▲ / ▼ / ► / ◄) to select “TEST TONE,” then press ENTER.

Test tone stops.

7 When finished, press Cursor (▲ / ▼ / ► / ◄) to move ◀ to “EXIT,” then press ENTER.

EXPERT SPEAKER SETTING menu disappears.

■ **Selecting the speaker for bass output**

You can select the speaker for bass output according to your preference.

1 Display EXPERT SPEAKER SETTING menu.

- See page 38.

2 Press Cursor (▲ / ▼ / ► / ◄) to move ◀ to “BASS,” then press ENTER.

3 Press Cursor ► or ◄ to select your desired setting.

- **L/R** : to output the bass signals through the subwoofers built-in the supplied front speakers.
- **S.woofer** : to output the bass signals through the subwoofer connected to the SUB-WOOFER 5.1ch OUT jack.

4 When finished, press Cursor (▲ / ▼ / ► / ◄) to move ◀ to “EXIT,” then press ENTER.

EXPERT SPEAKER SETTING menu disappears.

■ **Adjusting the subwoofer output levels**

You can adjust the output level according to your preference.

1 Display EXPERT SPEAKER SETTING menu.

- See page 38.

2 Press Cursor (▲ / ▼ / ► / ◄) to move ◀ to “SUB WOOFER,” then press ENTER.

- You can adjust the output level from “-6 dB” to “+6 dB.”

3 Press Cursor ► or ◄ to adjust the output level, then press ENTER.

4 When finished, press Cursor (▲ / ▼ / ► / ◄) to move ◀ to “EXIT,” then press ENTER.

EXPERT SPEAKER SETTING menu disappears.

Changing the Display Settings

On DISPLAY menu, you can change the following display settings.

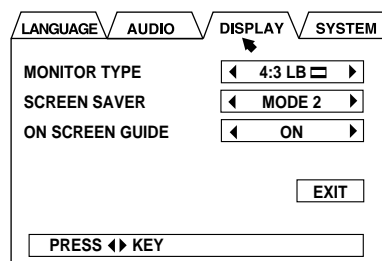

• **MONITOR TYPE :**

Set the monitor type to use while playing back a DVD recorded with 16:9 wide screen video signal.

Selectable types—4:3 LB , 16:9 WIDE, 4:3 PS
 (See page 42.)

• **SCREEN SAVER :**

Select the screen saver to prevent a TV monitor from burning out.

- Select “**MODE 1**” to activate the screen saver by making the TV screen dark.
- Select “**MODE 2**” to activate the screen saver by showing the original screen-saver.
- Select “**OFF**” to deactivate this function.

When “MODE 1” or “MODE 2” is selected, screen saver functions if still (static) picture is shown for more than 5 minutes.

• **ON SCREEN GUIDE :**

By watching the on-screen indications shown on the TV screen, you can confirm what you are doing while operating the DVD player.

- Select “**ON**” to show the on-screen indications.
- Select “**OFF**” to deactivate this function.



■ Monitor types

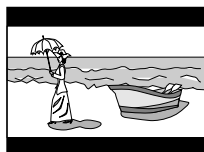

- **4:3 LB (Letter Box)** : Select this when viewing on TV whose aspect ratio is 4:3.

While viewing a wide screen picture, the black bars appear on the top and the bottom of the screen.

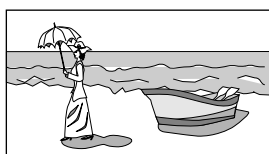

- **16:9 WIDE**: Select this when viewing on TV whose aspect ratio is 16:9.

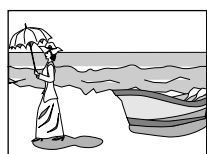

- **4:3 PS (Pan Scan)** : Select this when viewing on TV whose aspect ratio is 4:3.

While viewing a wide screen picture, the black bars do not appear, however, the left and right edge sides of the pictures will not be shown on the screen.

- **Even if “4:3 PS ” is selected**, the screen size may become “4:3 LB ” while playing some DVDs. This depends on how the DVD is programed and recorded.
- **If a disc (or some portions of the disc) is recorded with the video signals of 4:3 aspect ratio**, this setting does not take effect. The pictures are displayed with full 4:3 aspect ratio or with 4:3 Letter Box.

Changing the System Settings

On SYSTEM menu, you can change the following settings.

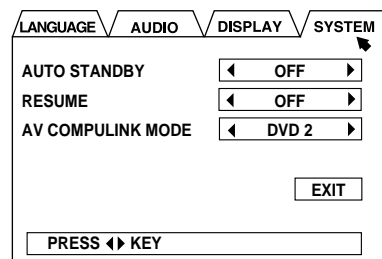

• AUTO STANDBY :

You can turn off (into standby) the unit automatically.

- Select “**30**” to turn off the unit automatically if no operation is done for 30 minutes.
- Select “**60**” to turn off the unit automatically if no operation is done for 60 minutes.
- Select “**OFF**” to deactivate this function.

• RESUME :

This unit can memorize the stop-point where DVD, SVCD or VCD playback stops. When the playback is selected again, it starts from where it has been stopped—Resume play.

- Select “**ON**” to activate Resume play.
- Select “**OFF**” to deactivate Resume play. Playback always starts from the beginning.

• AV COMPULINK MODE :

When connecting this unit to a JVC's TV with the AV COMPULINK remote control system, select the proper setting.

- Select “**DVD 1**” when connecting this unit to the COMPONENT VIDEO or INPUT-2 terminals on a TV.
- Select “**DVD 2**” when connecting this unit to the INPUT-1 terminals on a TV.
- Select “**DVD 3**” when connecting this unit to the INPUT-2 terminals on a TV.

* For AV COMPU LINK control system, see page 48.



Using the Parental Lock

Setting the Parental Lock Level

Using this function, you can restrict playback of DVD containing violent scenes (and those not suitable for your family members).

- This function is only possible for the DVDs containing such rating level information (Level 1 to Level 8).

On the remote control ONLY:

Before setting the parental lock, make sure that no disc is loaded on the currently selected tray.

1 Press ENTER while holding down ■.

PARENTAL LOCK screen appears.

- When you set the parental lock for the first time, ◀ points “Country Code.” (Go to step 3.)
- When you change the parental lock settings, ◀ points “PASSWORD.”

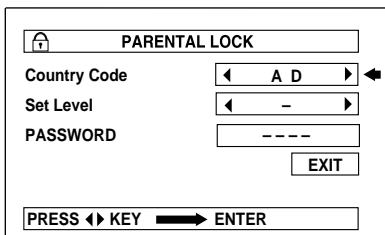
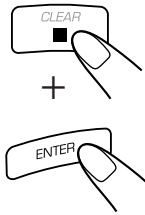

Initial PARENTAL LOCK screen

2 Press the number buttons (0 – 9) to enter the current password (4 digits), then press ENTER.

◀ moves to “Country Code.”

- If you enter a wrong password, “WRONG! RETRY...” appears. Enter correct password again.

3 Press Cursor ▶ or ◀ to select a proper country code, then press ENTER.

◀ moves to “Set Level.”

- For each country code, see pages 53 and 54.

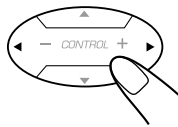

4 Press Cursor ▶ or ◀ to select a parental lock level, then press ENTER.

◀ moves to “PASSWORD.”

- Each time you press the button, the parental lock level changes as follows. Discs rated higher than the selected level are restricted.

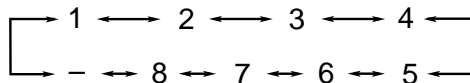

- If you do not want to make any restriction, select “-.”

5 Press the number buttons (0 – 9) to enter new password (4 digits), then press ENTER.

◀ moves to “EXIT.”

6 Press ENTER.

The parental lock level is set and PARENTAL LOCK screen disappears from the TV.

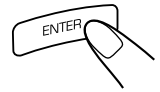

To exit from PARENTAL LOCK screen any time during the above procedure, press ENTER while holding down ■.



If you do not enter new password The setting you have done is not stored.

Unlocking the Parental Lock Temporarily

Some discs cannot be played back at all when the parental lock is set. If you insert such a disc and try to play, the following PARENTAL LOCK screen appears on the TV. You can unlock the parental lock setting temporarily on this screen.

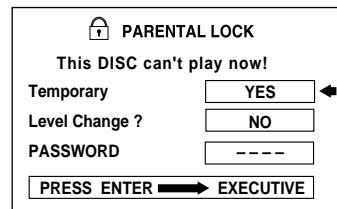

On the remote control ONLY:

1 Press Cursor ▲ or ▼ to select “YES,” then press ENTER.

◀ moves to “PASSWORD.”

- If you do not unlock the parental lock (do not see the loaded DVD), move ◀ to “NO” for “Level Change ?.” PARENTAL LOCK screen disappears.

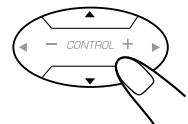

2 Press the number buttons (0 – 9) to enter the current password (4 digits).

- If you enter a wrong password, “WRONG! RETRY...” appears. Enter correct password again.

3 Press ENTER.

The parental lock is temporarily unlocked and PARENTAL LOCK screen disappears.



If you enter wrong password 3 times, “WRONG! CAN’T CHANGE!” appears on the screen. ◀ moves to “EXIT” and Cursor ▲ and ▼ do not work. When you forget your password, enter “8888.”

There are three timers available—Daily Timer, Recording Timer, and Sleep Timer.

Before using the timers, you need to set the clock built in the unit. (See page 11.)

Using Daily Timer

With Daily Timer, you can wake to your favorite music or radio program. You can set the timer whether the unit is on or off (on standby).

How Daily Timer actually works

The unit automatically turns on, set the volume level to the preset level, and starts playing the specified source when the on-time comes (the ☺ indicator continues flashing while the timer is operating). Then, when the off-time comes (“OFF” flashes just before the off-time), the unit automatically turns off (on standby).

The Daily timer works everyday automatically. If you do not want to use the Daily timer, turn off the Daily timer. (See “To turn off or on Daily Timer after its setting is done” on the next page.) The timer setting remains in memory until you change it.

- There is a time limit in doing the following steps. If the setting is canceled before you finish, start from step 1 again.
- To correct a misentry while setting the timer, press CANCEL/DEMO.

Before you start...

- *When using a DVD, SVCD or VCD as the source to play—*
 - Make sure that a TV is set to turn on at the setting time and the correct input mode is selected.
 - Make sure there is a disc on the selected disc number tray.
- *When using a CD as the source to play—*
 - Make sure there is a disc on the selected disc number tray.
- *When using a tape as the source to play—*
 - Make sure that a tape is in the deck whose deck indicator (A or B) is lit on the display.
 - Make sure that the tape direction is correct.
- *When using tuner as the source to play—*
 - Set the preset stations.
- *When using the external component as the source to play—*
 - Set the timer equipped on the external component at the same time.

On the unit ONLY:

- 1 Press **CLOCK/TIMER** repeatedly until “DAILY” appears on the display.

☺ indicator lights up and DAILY (Daily Timer) indicator also starts flashing on the display.

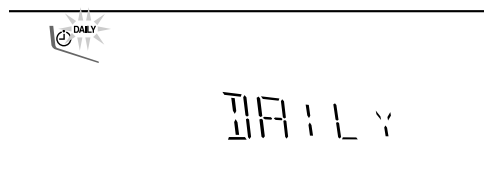

- Each time you press the button, the timer setting modes change as follows:

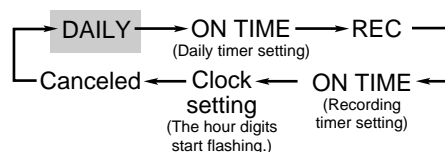

- 2 Press **CLOCK/TIMER** again.

“ON TIME” appears for 2 seconds on the display, then the unit enters on-time setting mode.



- 3 Set the on-time you want the unit to turn on at.

- 1) Turn **◀◀ / ▶▶** to set the hour, then press **SET**.
- 2) Turn **◀◀ / ▶▶** to set the minute, then press **SET**. “OFF TIME” appears for 2 seconds on the display, then the unit enters off-time setting mode.

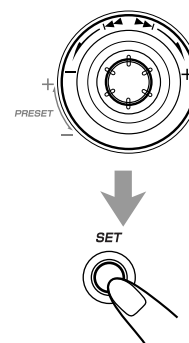

- 4 Set the off-time you want the unit to turn off (on standby) at.

- 1) Turn **◀◀ / ▶▶** to set the hour, then press **SET**.
- 2) Turn **◀◀ / ▶▶** to set the minute, then press **SET**. The unit enters source selecting mode.

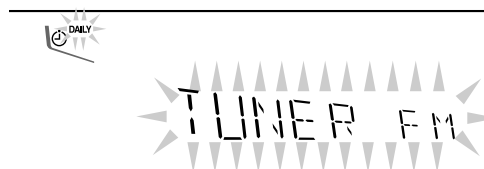

5 Turn |◀◀ / ▶▶| to select the source to play, then press SET.

- The source changes as follows:



- TUNER FM: tunes into a specified preset FM station. → **Go to step 6.**
- TUNER AM: tunes into a specified preset AM station. → **Go to step 6.**
- DISC- - -: plays a disc from a specified title or track of a specified disc. → **Go to step 6.**
- TAPE: plays a tape in deck A or B. → **Go to step 7.**
- AUX: plays an external source. → **Go to step 7.**

6 When selecting “TUNER FM” or “TUNER AM”

Turn |◀◀ / ▶▶| to select the preset station number, then press SET.

The unit enters volume setting mode.

When selecting “DISC- - -”

- 1) Turn |◀◀ / ▶▶| to select the disc number, then press SET.
- 2) Turn |◀◀ / ▶▶| to set the title or track number, then press SET.
The unit enters volume setting mode.

7 Turn |◀◀ / ▶▶| to set the volume level.

- The volume level changes as follows:

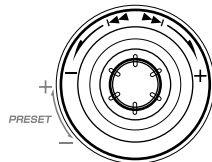
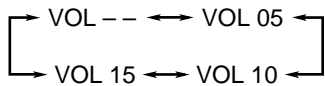

- If you select “VOL --,” the volume is set to the last level when the unit has been turned off.

8 Press SET to complete the Daily Timer setting.

The DAILY (Daily Timer) indicator stops flashing and remains lit. The settings you have done are shown on the display in sequence.

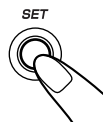

9 Press STANDBY/ON ⏻/⏻ to turn off the unit (on standby) if you have set the Daily Timer with the unit turned on.

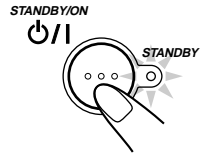

If the unit is turned on when the on-time comes Daily Timer does not work.



Even if you unplug the AC power cord or if a power failure occurs

Once you set the timer, the timer setting may remain stored in memory for a few days. In this case, check whether the timer setting still remains or not.

To turn off or on Daily Timer after its setting is done

- 1 Press CLOCK/TIMER repeatedly until “DAILY” appears on the display.



- 2 To turn off the Daily Timer, press CANCEL/DEMO.

⏻ indicator and the DAILY (Daily Timer) indicator go off from the display (“OFF” appears for a while). The Daily Timer is canceled, but the setting for the Daily Timer remains in memory.

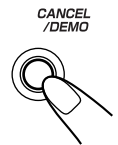

To turn on the Daily Timer, press SET.

⏻ indicator and the DAILY (Daily Timer) indicator light up on the display. The settings you have done are shown on the display in sequence for your confirmation.



Using Recording Timer

With Recording Timer, you can make a tape of a radio broadcast automatically. You can set the timer whether the system is on or off.

How Recording Timer actually works

The unit automatically turns on, tunes into the specified station, sets the volume level to "VOL MIN," and starts recording when the on-time comes (the  indicator continues flashing while the timer is operating). Then, when the off-time comes ("OFF" flashes just before the off-time), the unit automatically turns off (on standby).

The timer setting remains in memory until you change it.

- There is a time limit in doing the following steps. If the setting is canceled before you finish, start from step 2 again.
- To correct a misentry while setting the timer, press CANCEL/DEMO.

On the unit ONLY:

1 Put a recordable cassette into deck B.

2 Press CLOCK/TIMER repeatedly until "REC" appears on the display.

 indicator lights up and the REC (Recording Timer) indicator also starts flashing on the display.

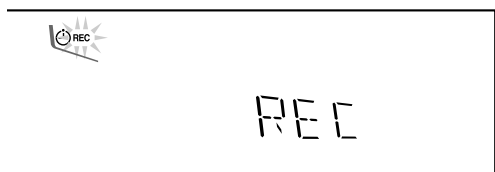

- Each time you press the button, the timer setting modes change as follows:

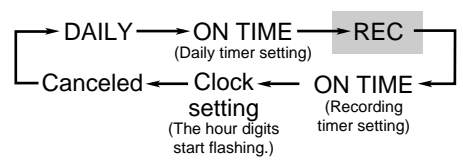





3 Press CLOCK/TIMER again.

"ON TIME" appears for 2 seconds on the display, then the unit enters on-time setting mode.





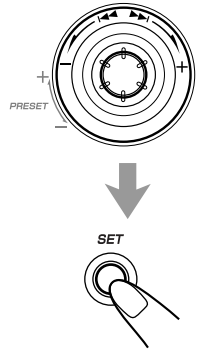

4 Set the on-time you want the unit to turn on at.





- 1) Turn  /  to set the hour, then press SET.
 - 2) Turn  /  to set the minute, then press SET.
- "OFF TIME" appears for 2 seconds on the display, then the unit enters off-time setting mode.



5 Set the off-time you want the unit to turn off (on standby) at.

- 1) Turn  /  to set the hour, then press SET.
 - 2) Turn  /  to set the minute, then press SET.
- The unit enters preset station selecting mode.

6 Select the preset station.

- 1) Turn  /  to select the band ("TUNER FM" or "TUNER AM"), then press SET.
- 2) Turn  /  to select a preset channel number, then press SET.

The REC (Recording Timer) indicator stops flashing and remains lit. The settings you have done are shown on the display in sequence.

7 Press STANDBY/ON to turn off the unit (on standby) if necessary.

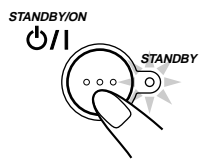

If you want to listen to another source while recording
Press REC START/STOP or  to stop recording. Without stopping it, you cannot change the source.



Even if you unplug the AC power cord or if a power failure occurs

Once you set the timer, the timer setting may remain stored in memory in a few days. In this case, check whether the timer setting still remains or not.



To turn off or on Recording Timer after its setting is done

1 Press **CLOCK/TIMER** repeatedly until “REC” appears on the display.



2 To turn off the Recording Timer, press **CANCEL/DEMO**.

⊖ indicator and the REC (Recording Timer) indicator go off from the display (“OFF” appears for a while).



The Recording Timer is canceled, but the setting for the Recording Timer remains in memory.

To turn on the Recording Timer, press **SET**.

⊖ indicator and the REC (Recording Timer) indicator light up on the display. The settings you have done are shown on the display in sequence for your confirmation.

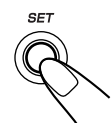

Using Sleep Timer

With Sleep Timer, you can fall asleep to sound. You can set Sleep Timer only while the unit is turned on.

How Sleep Timer actually works

The unit automatically turns off after the specified time length passes.

On the remote control ONLY:

1 Press **SLEEP**.

The time length until the shut-off time appears and the SLEEP indicator starts flashing on the display.



- Each time you press the button, the time length changes as follows:

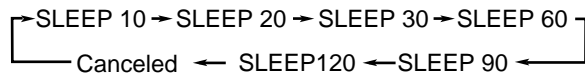

2 Wait for about 5 seconds after specifying the time length.

The SLEEP indicator stops flashing and remains lit.

To check the remaining time until the shut-off time, press SLEEP once so that the remaining time until the shut-off time appears for about 5 seconds.

To change the shut-off time, press SLEEP repeatedly until the desired time length appears on the display.

To cancel the setting, press SLEEP repeatedly so that the SLEEP indicator goes off.

- Sleep Timer is also canceled when you turn off the unit.

Timer Priority

Since each timer can be set separately, you may wonder what happens if the setting for these timers overlaps. Here are examples.

Recording Timer has priority over Daily Timer and Sleep Timer.

- If Daily Timer is set to come on while Recording Timer is operating, Daily Timer will not come on at all.

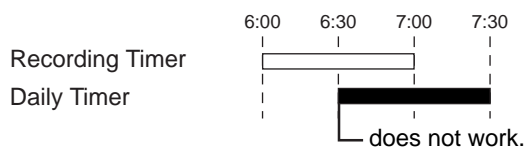

- If Recording Timer is set to come on while Sleep Timer is operating, Sleep Timer will not work (the SLEEP indicator does not go off).

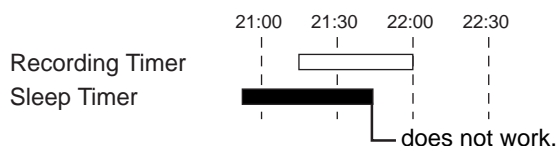

Using AV COMPU LINK Control System



The AV COMPU LINK control system allows you to use JVC's TV with simple operations.

To use AV COMPU LINK control system, you need to connect this unit and a TV through the AV COMPU LINK terminals.

- You can connect a TV that has AV COMPU LINK II or AV COMPU LINK EX terminals.

AV COMPU LINK Connection

Connect a TV by using a video cord (see page 10) then also connect it by using a cord with monaural mini-plugs (not supplied).

- You need to set "AV COMPULINK MODE" correctly to use AV COMPU LINK control system. (See page 42.)

Available operations

You can use following functions by using AV COMPU LINK control system.

Automatic power on/off

The connected TV turns on and off along with this unit. When you turn on the unit the connected TV automatically turns on and changes the input mode to the appropriate position. Also when you turn off the unit, the connected TV automatically turns off.

One-touch disc play

Simply by inserting or playing back a disc, you can enjoy the playback view on the TV without setting other switches manually.

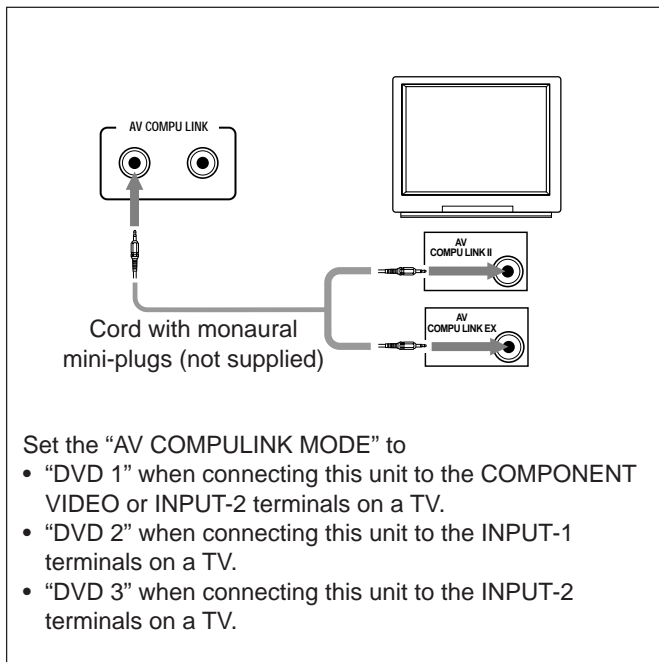

Appendix A—Maintenance

To get the best performance of the unit, keep your discs, tapes, and mechanism clean.

Handling discs



- Remove the disc from its case by holding it at the edge while pressing the center hole lightly.
- Do not touch the shiny surface of the disc, or bend the disc.
- Put the disc back in its case after use to prevent warping.

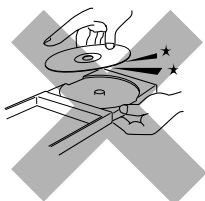

- Be careful not to scratch the surface of the disc when placing it back in its case.
- Avoid exposure to direct sunlight, temperature extremes, and moisture.

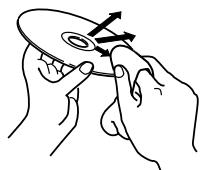

To clean the disc

Wipe the disc with a soft cloth in a straight line from center to edge.



DO NOT use any solvent—such as conventional record cleaner, spray, thinner, or benzene—to clean the disc.

Handling cassette tapes

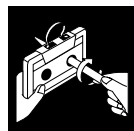

- If the tape is loose in its cassette, take up the slack by inserting a pencil in one of the reels and rotating.
- If the tape is loose, it may get stretched, cut, or caught in the cassette.



- Be careful not to touch the tape surface.



- Avoid the following places to store the tape:
 - In dusty places
 - In direct sunlight or heat
 - In moist areas
 - Near a magnet

Cleaning the unit

• Stains on the unit

Should be wiped off with a soft cloth. If the unit is heavily stained, wipe it with a cloth soaked in water diluted neutral detergent and wrung well, then wipe clean with a dry cloth.

• Since the unit may deteriorate in quality, become damaged or get its paint peeled off, be careful about the followings.

- DO NOT wipe it with a hard cloth.
- DO NOT wipe it strong.
- DO NOT wipe it with thinner or benzene.
- DO NOT apply any volatile substance such as insecticides to it.
- DO NOT allow any rubber or plastic to remain in contact with it for a long time.

Appendix B—Troubleshooting

If you are having a problem with your unit, check this list for a possible solution before calling for service. If you cannot solve the problem from the hints given here, or the unit has been physically damaged, call a qualified person, such as your dealer, for service.

Symptom	Cause	Action
Unable to cancel the display demonstration.	Other buttons are pressed to cancel the display demonstration.	Press CANCEL/DEMO on the unit. (See page 10.)
No sound is heard.	<ul style="list-style-type: none"> • Connections are incorrect or loose. • You are playing a disc encoded with DTS Digital Surround. 	<ul style="list-style-type: none"> • Check all connections and make corrections. (See pages 6 to 10.) • This unit cannot output DTS sound without connecting a decoder compatible with DTS Digital Surround (with “DIGITAL AUDIO OUTPUT” to “STREAM/PCM”—See page 39.)
Hard to listen to broadcasts because of noise.	<ul style="list-style-type: none"> • Antennas are disconnected. • The AM loop antenna is too close to the unit. • The FM antenna is not properly extended and positioned. 	<ul style="list-style-type: none"> • Reconnect the antennas correctly and securely. • Change the position and direction of the AM loop antenna. • Extend the FM antenna at the best position.
The disc sound is discontinuous.	The disc is scratched or dirty.	Clean or replace the disc. (See page 49.)
The disc tray does not open or close.	<ul style="list-style-type: none"> • The AC power cord is not plugged in. • Trays are locked. 	<ul style="list-style-type: none"> • Plug the AC power cord. • Unlock the trays. (See page 22.)
The disc does not play.	The disc is placed upside down.	Place the disc with the label side up.
The disc reading time is too long or the disc cannot be ejected by pressing ▲.	The disc is placed upside down.	Change source to another one (ex. FM/AM), eject the disc, and place it with the label side up.
Impossible to turn off Pro Logic while playing back a CD.	“ON” is selected as Pro Logic setting.	Show the on-screen menu by selecting a DVD, SVCD or VCD as a playing source or leaving the disc tray opened, then change the Pro Logic setting to “AUTO” or “OFF.” (See page 39.)
No picture appears on the screen.	<ul style="list-style-type: none"> • The video cord is not connected correctly. • Incorrect color system is selected. • An incorrect input has been selected on the TV or monitor. 	<ul style="list-style-type: none"> • Connect the video cord correctly. • Select correct color system (See page 10.) • Select the correct input on the TV or monitor.
DVD does not play back.	Parental lock is in use.	Unlock the parental lock. (See page 43.)
The left and right edges of the picture are missing on the screen.	“4:3 PS <input type="checkbox"/> ” is selected when viewing on a conventional TV (aspect ratio 4:3).	Select “4:3 LB <input type="checkbox"/> . ” (See page 41.)</td
No subtitle appears on the display though you have selected the initial subtitle language.		Some DVDs are programed to always display no subtitle initially. If this happens, press SUBTITLE on the remote control after starting play. (See page 39.)
Audio language is different from the one you have selected as the initial audio language.		Some DVDs are programed to always use the original language initially. If this happens, press AUDIO while holding down SHIFT on the remote control after starting play. (See page 39.)
Impossible to record.	Small tabs on the top of the cassette are removed.	Cover the holes with adhesive tape.
Stereo effect is lost.	Vocal Masking is activated.	Cancel the Vocal Masking. (See page 35.)
Operations are disabled.	The built-in microprocessor may malfunction due to external electrical interference.	Unplug the AC power cord and then plug it back in.
Unable to operate the unit from the remote control.	<ul style="list-style-type: none"> • The path between the remote control and the remote sensor on the unit is blocked. • The batteries are exhausted. 	<ul style="list-style-type: none"> • Remove the obstruction. • Replace the batteries.

Appendix C—Output Signals Through the OPTICAL DIGITAL OUTPUT Terminal

They differ according to the “DIGITAL AUDIO OUTPUT” setting. (See page 39.)

DIGITAL AUDIO OUTPUT Playback disc	Output Signals		
	STREAM	DOLBY DIGITAL/PCM	PCM ONLY
DVD with 48 kHz, Linear PCM	48 kHz, Linear PCM	48 kHz, Linear PCM	48 kHz, Linear PCM
with 96 kHz, Linear PCM	48 kHz, Linear PCM	48 kHz, Linear PCM	48 kHz, Linear PCM
with Dolby Digital	Dolby Digital bitstream	Dolby Digital bitstream	48 kHz, Linear PCM
with DTS Digital Surround	DTS bitstream		
with MPEG Audio	MPEG bitstream	48 kHz, Linear PCM	48 kHz, Linear PCM
Video CD, Audio CD	44.1 kHz, 16 bit Linear PCM	44.1 kHz, 16 bit Linear PCM	44.1 kHz, 16 bit Linear PCM
Audio CD with DTS	DTS bitstream	44.1 kHz, 16 bit Linear PCM	44.1 kHz, 16 bit Linear PCM

Appendix D—Channel Display

Current outputting channel appears on the display when you press DISPLAY. (See page 17.)

DOLBY DIGITAL

Display	LFE	Channel
1/0 CH		C ONLY
1/0.1 CH	ON	C ONLY
2/0 CH		L/R
2/0.1 CH	ON	L/R
2/0 CH		L/R (L0/R0)
2/0.1 CH	ON	L/R (L0/R0)
2/0 CH		L/R/S (Lt/Rt)
2/0.1 CH	ON	L/R/S (Lt/Rt)
3/0 CH		L/C/R
3/0.1 CH	ON	L/C/R
2/1 CH		L/R/S
2/1.1 CH	ON	L/R/S
3/1 CH		L/C/R/S
3/1.1 CH	ON	L/C/R/S
2/2 CH		L/R/LS/RS
2/2.1 CH	ON	L/R/LS/RS
3/2 CH		L/C/R/LS/RS
3/2.1 CH	ON	L/C/R/LS/RS

Linear PCM and DTS

Display	Channel
1 CH	Monaural
2 CH	2 ch stereo
3 CH	3 ch
4 CH	4 ch
5 CH	5 ch
6 CH	6 ch
7 CH	7 ch
8 CH	8 ch

MPEG

Display	Channel
2/0 CH	Monaural
2/0.1 CH	2 ch stereo
2/2 CH	3 ch
3/0 CH	4 ch
2/2.1 CH	5 ch
3/0.1 CH	6 ch
3/2 CH	7 ch
3/2.1 CH	8 ch
2/0 CH	(down mix)

Appendix E—Language Code for On-Screen Menu

This code list is used when you select a language of on-screen menus. (See page 39.)

Code	Language	Code	Language	Code	Language
AA	Afar	IK	Inupiak	RN	Kirundi
AB	Abkhazian	IN	Indonesian	RO	Rumanian
AF	Afrikaans	IS	Icelandic	RU	Russian
AM	Ameharic	IW	Hebrew	RW	Kinyarwanda
AR	Arabic	JI	Yiddish	SA	Sanskrit
AS	Assamese	JW	Javanese	SD	Sindhi
AY	Aymara	KA	Georgian	SG	Sangho
AZ	Azerbaijani	KK	Kazakh	SH	Serbo-Croatian
BA	Bashkir	KL	Greenlandic	SI	Singhalese
BE	Byelorussian	KM	Cambodian	SK	Slovak
BG	Bulgarian	KN	Kannada	SL	Slovenian
BH	Bihari	KO	Korean (KOR)	SM	Samoan
BI	Bislama	KS	Kashmiri	SN	Shona
BN	Bengali, Bangla	KU	Kurdish	SO	Somali
BO	Tibetan	KY	Kirghiz	SQ	Albanian
BR	Breton	LA	Latin	SR	Serbian
CA	Catalan	LN	Lingala	SS	Siswati
CO	Corsican	LO	Laothian	ST	Sesotho
CS	Czech	LT	Lithuanian	SU	Sundanese
CY	Welsh	LV	Latvian, Lettish	SV	Swedish
DA	Danish	MG	Malagasy	SW	Swahili
DZ	Bhutani	MI	Maori	TA	Tamil
EL	Greek	MK	Macedonian	TE	Telugu
EO	Esperanto	ML	Malayalam	TG	Tajik
ET	Estonian	MN	Mongolian	TH	Thai
EU	Basque	MO	Moldavian	TI	Tigrinya
FA	Persian	MR	Marathi	TK	Turkmen
FI	Finnish	MS	Malay (MAY)	TL	Tagalog
FJ	Fiji	MT	Maltese	TN	Setswana
FO	Faroese	MY	Burmese	TO	Tonga
FY	Frisian	NA	Nauru	TR	Turkish
GA	Irish	NE	Nepali	TS	Tsonga
GD	Scots Gaelic	NL	Dutch	TT	Tatar
GL	Galician	NO	Norwegian	TW	Twi
GN	Guarani	OC	Occitan	UK	Ukrainian
GU	Gujarati	OM	(Afan) Oromo	UR	Urdu
HA	Hausa	OR	Oriya	UZ	Uzbek
HI	Hindi	PA	Panjabi	VI	Vietnamese
HR	Croatian	PL	Polish	VO	Volapuk
HU	Hungarian	PS	Pashto, Pushto	WO	Wolof
HY	Armenian	PT	Portuguese	XH	Xhosa
IA	Interlingua	QU	Quechua	YO	Yoruba
IE	Interlingue	RM	Rhaeto-Romance	ZU	Zulu

Appendix F—Country Code for Parental Lock

This code list is used when you set a country code for parental lock. (See page 43.)

Code	Country	Code	Country	Code	Country
AD	Andorra	CM	Cameroon	GR	Greece
AE	United Arab Emirates	CN	China	GS	South Georgia and the South Sandwich Islands
AF	Afghanistan	CO	Colombia	GT	Guatemala
AG	Antigua and Barbuda	CR	Costa Rica	GU	Guam
AI	Anguilla	CU	Cuba	GW	Guinea-Bissau
AL	Albania	CV	Cape Verde	GY	Guyana
AM	Armenia	CX	Christmas Island	HK	Hong Kong
AN	Netherlands Antilles	CY	Cyprus	HM	Heard Island and McDonald Islands
AO	Angola	CZ	Czech Republic	HN	Honduras
AQ	Antarctica	DE	Germany	HR	Croatia
AR	Argentina	DJ	Djibouti	HT	Haiti
AS	American Samoa	DK	Denmark	HU	Hungary
AT	Austria	DM	Dominica	ID	Indonesia
AU	Australia	DO	Dominican Republic	IE	Ireland
AW	Aruba	DZ	Algeria	IL	Israel
AZ	Azerbaijan	EC	Ecuador	IN	India
BA	Bosnia and Herzegovina	EE	Estonia	IO	British Indian Ocean Territory
BB	Barbados	EG	Egypt	IQ	Iraq
BD	Bangladesh	EH	Western Sahara	IR	Iran (Islamic Republic of)
BE	Belgium	ER	Eritrea	IS	Iceland
BF	Burkina Faso	ES	Spain	IT	Italy
BG	Bulgaria	ET	Ethiopia	JM	Jamaica
BH	Bahrain	FI	Finland	JO	Jordan
BI	Burundi	FJ	Fiji	JP	Japan
BJ	Benin	FK	Falkland Islands (Malvinas)	KE	Kenya
BM	Bermuda	FM	Micronesia (Federated States of)	KG	Kyrgyzstan
BN	Brunei Darussalam	FO	Faroe Islands	KH	Cambodia
BO	Bolivia	FR	France	KI	Kiribati
BR	Brazil	FX	France, Metropolitan	KM	Comoros
BS	Bahamas	GA	Gabon	KN	Saint Kitts and Nevis
BT	Bhutan	GB	United Kingdom	KP	Korea, Democratic People's Republic of
BV	Bouvet Island	GD	Grenada	KR	Korea, Republic of
BW	Botswana	GE	Georgia	KW	Kuwait
BY	Belarus	GF	French Guiana	KY	Cayman Islands
BZ	Belize	GH	Ghana	KZ	Kazakhstan
CA	Canada	GI	Gibraltar	LA	Lao People's Democratic Republic
CC	Cocos (Keeling) Islands	GL	Greenland	LB	Lebanon
CF	Central African Republic	GM	Gambia	LC	Saint Lucia
CG	Congo	GN	Guinea		
CH	Switzerland	GP	Guadeloupe		
CI	Côte d'Ivoire	GQ	Equatorial Guinea		
CK	Cook Islands				
CL	Chile				

Code	Country	Code	Country	Code	Country
LI	Liechtenstein	PE	Peru	TJ	Tajikistan
LK	Sri Lanka	PF	French Polynesia	TK	Tokelau
LR	Liberia	PG	Papua New Guinea	TM	Turkmenistan
LS	Lesotho	PH	Philippines	TN	Tunisia
LT	Lithuania	PK	Pakistan	TO	Tonga
LU	Luxembourg	PL	Poland	TP	East Timor
LV	Latvia	PM	Saint Pierre and Miquelon	TR	Turkey
LY	Libyan Arab Jamahiriya			TT	Trinidad and Tobago
MA	Morocco	PN	Pitcairn	TV	Tuvalu
MC	Monaco	PR	Puerto Rico	TW	Taiwan
MD	Moldova, Republic of	PT	Portugal	TZ	Tanzania, United Republic of
MG	Madagascar	PW	Palau		
MH	Marshall Islands	PY	Paraguay	UA	Ukraine
ML	Mali	QA	Qatar	UG	Uganda
MM	Myanmar	RE	Réunion	UM	United States Minor Outlying Islands
MN	Mongolia	RO	Romania		
MO	Macau	RU	Russian Federation	US	United States
MP	Northern Mariana Islands	RW	Rwanda	UY	Uruguay
		SA	Saudi Arabia	UZ	Uzbekistan
MQ	Martinique	SB	Solomon Islands	VA	Vatican City State (Holy See)
MR	Mauritania	SC	Seychelles		
MS	Montserrat	SD	Sudan	VC	Saint Vincent and the Grenadines
MT	Malta	SE	Sweden		
MU	Mauritius	SG	Singapore	VE	Venezuela
MV	Maldives	SH	Saint Helena	VG	Virgin Islands (British)
MW	Malawi	SI	Slovenia	VI	Virgin Islands (U.S.)
MX	Mexico	SJ	Svalbard and Jan Mayen	VN	Viet Nam
MY	Malaysia	SK	Slovakia	VU	Vanuatu
MZ	Mozambique	SL	Sierra Leone	WF	Wallis and Futuna Islands
NA	Namibia	SM	San Marino		
NC	New Caledonia	SN	Senegal	WS	Samoa
NE	Niger	SO	Somalia	YE	Yemen
NF	Norfolk Island	SR	Suriname	YT	Mayotte
NG	Nigeria	ST	Sao Tome and Principe	YU	Yugoslavia
NI	Nicaragua	SV	El Salvador	ZA	South Africa
NL	Netherlands	SY	Syrian Arab Republic	ZM	Zambia
NO	Norway	SZ	Swaziland	ZR	Zaire
NP	Nepal	TC	Turks and Caicos Islands	ZW	Zimbabwe
NR	Nauru	TD	Chad		
NU	Niue	TF	French Southern Territories		
NZ	New Zealand				
OM	Oman	TG	Togo		
PA	Panama	TH	Thailand		

Appendix G—Glossary

4:3 Letter Box screen

This is one method for displaying a wide screen picture on a conventional sized (4:3) TV. While viewing a wide screen picture, the black bars appear on the top and the bottom of the screen.

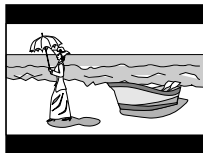

4:3 Pan-Scan screen

This is one method for displaying a wide screen picture on a conventional sized (4:3) TV. While viewing a wide screen picture, the left and right edges of the pictures will not be shown on the screen.

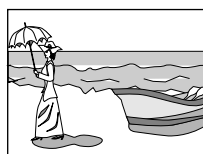

Dolby Digital

This is a digital audio compression technology that was developed by Dolby Laboratories. Dolby Digital encoding method (so-called discrete 5.1 channel digital audio format) records and compresses the left front channel, right front channel, center channel, left rear channel, right rear channel, and LFE channel (total 6 channels, but LFE channel is counted as 0.1 channel, therefore called 5.1 channels) signals digitally. Each channel is completely independent from other channel signals to avoid interference, therefore, you can obtain much better sound quality with stereo and surround effects. To reproduce these original surround signals, you need to connect an amplifier or a decoder compatible with Dolby Digital.

DTS Digital Surround

Another discrete 5.1 channel digital audio format, available on CD, LD, and DVD software, developed by Digital Theater Systems, Inc. Compared to Dolby Digital, audio compression rate is relatively low. This fact allows DTS Digital Surround format to add breadth and depth to the reproduced sounds. As a result, DTS Digital Surround features natural, solid and clear sound.

To reproduce these surround signals, you need to connect an amplifier or a decoder compatible with DTS Digital Surround.

Linear PCM

This is a digital recording format that is used for audio CDs.

MPEG Multichannel

Digital audio compression format used for PAL/SECAM DVD software. (MPEG stands for “Moving Picture Experts Group” and has been originally developed for compressing video signals.) MPEG Multichannel is 5.1 channel surround using MPEG Audio coding format.

Playback Control (SVCD, VCD)

When a VCD has the PBC (Playback Control) function, you can enjoy menu-driven operations and high-resolution still pictures.

Sampling Frequency, Quantization Bits

When analog signals are converted into digital signals, they are divided into many points and digitized. This dividing method is called “sampling.” The sampling frequency indicates how many points one second is divided into – for example, for CD sound, one second is divided into 44100 points since its sampling frequency is 44.1 kHz. On the other hand, the number of quantization bits indicates the volume size used to memorize each divided point. The larger this number is, the clearer the sound can be reproduced.

Titles and Chapters (DVD)

A DVD is divided into several titles (large divisions), and each title is divided into chapters (smaller divisions). These divisions are assigned their particular numbers, so that they are easily accessed.

Tracks (SVCD, VCD, CD)

SVCD, VCDs and CDs are divided into tracks. Each track has its own number so that it is easily accessed.

Specifications

Design and specifications are subject to change without notice.

CA-MXDVA9

Output Power

FRONT SUBWOOFERS:

90 W per channel, min. RMS, driven into 6 Ω at 63 Hz with no more than 10% total harmonic distortion.

FRONT MAIN SPEAKERS:

45 W per channel, min. RMS, driven into 6 Ω at 1 kHz with no more than 10% total harmonic distortion.

SURROUND (REAR and CENTER) SPEAKERS:

25 W per channel, min. RMS, driven into 16 Ω at 1 kHz with no more than 10% total harmonic distortion.

Audio input sensitivity/Impedance

(Measured at 1 kHz, with tape recording signal 300 mV)

AUX: 410 mV/50 kΩ

Audio output level

AUX: 290 mV

MIC 1/2: 3.0 mV/5 kΩ

Dolby Digital 5.1ch subwoofer (LFE) output level

(measured when playing Dolby Digital 5.1ch track with LFE of 30 Hz at 0 dBFS)

SUB-WOOFER 5.1ch OUT: 170 mV

Digital output: OPTICAL DIGITAL OUTPUT

Signal wave length: 660 nm

Output level: -15 dBm to -12 dBm

AV OUT

COMP.: 1 V(p-p)/75 Ω

S-video:

Y (luminance) 1 V(p-p)/75 Ω

C (chrominance, burst) 0.286 V(p-p)/75 Ω

Speakers/Impedance

FRONT SUBWOOFERS: 6 Ω – 16 Ω

FRONT MAIN SPEAKERS: 6 Ω – 16 Ω

SURROUND SPEAKERS: 16 Ω – 32 Ω

Tuner

FM tuning range: 87.5 MHz – 108.0 MHz

AM tuning range:

For Saudi Arabia:

At 9 kHz intervals: 531 kHz – 1 602 kHz

At 10 kHz intervals: 530 kHz – 1 600 kHz

For other countries:

At 9 kHz intervals: 531 kHz – 1 710 kHz

At 10 kHz intervals: 530 kHz – 1 710 kHz

DVD player

Disc capacity: 3 discs

Readable disc: DVD Video, S-Video CD, Video CD, Audio CD, CD-R, CD-RW

Video format: NTSC/PAL compatibility

Frequency response

DVD, fs=48 kHz: 16 Hz to 22 000 Hz

DVD, fs=96 kHz: 16 Hz to 44 000 Hz

SVCD, VCD, CD: 16 Hz to 20 000 Hz

Dynamic range: 85 dB

Signal-to-noise ratio: 90 dB

Wow and flutter: Immeasurable

Cassette deck

Frequency response

Normal (type I): 50 Hz – 14 000 Hz

Wow and flutter: 0.15% (WRMS)

General

Power requirement: AC 110 V / AC 127 V / AC 220 V / AC 230 V – AC 240 V \sim (adjustable with the voltage selector), 50 Hz / 60 Hz

Power consumption: 175 W (at operation)
29 W (on standby)

Dimensions (approx.): 265 mm x 335 mm x 401 mm (W/H/D)

Mass (approx.): 10.3 kg

Supplied accessories

See page 6.

Mains (AC) Line Instruction (not applicable for Europe, U.S.A., Canada, Australia, and U.K.)

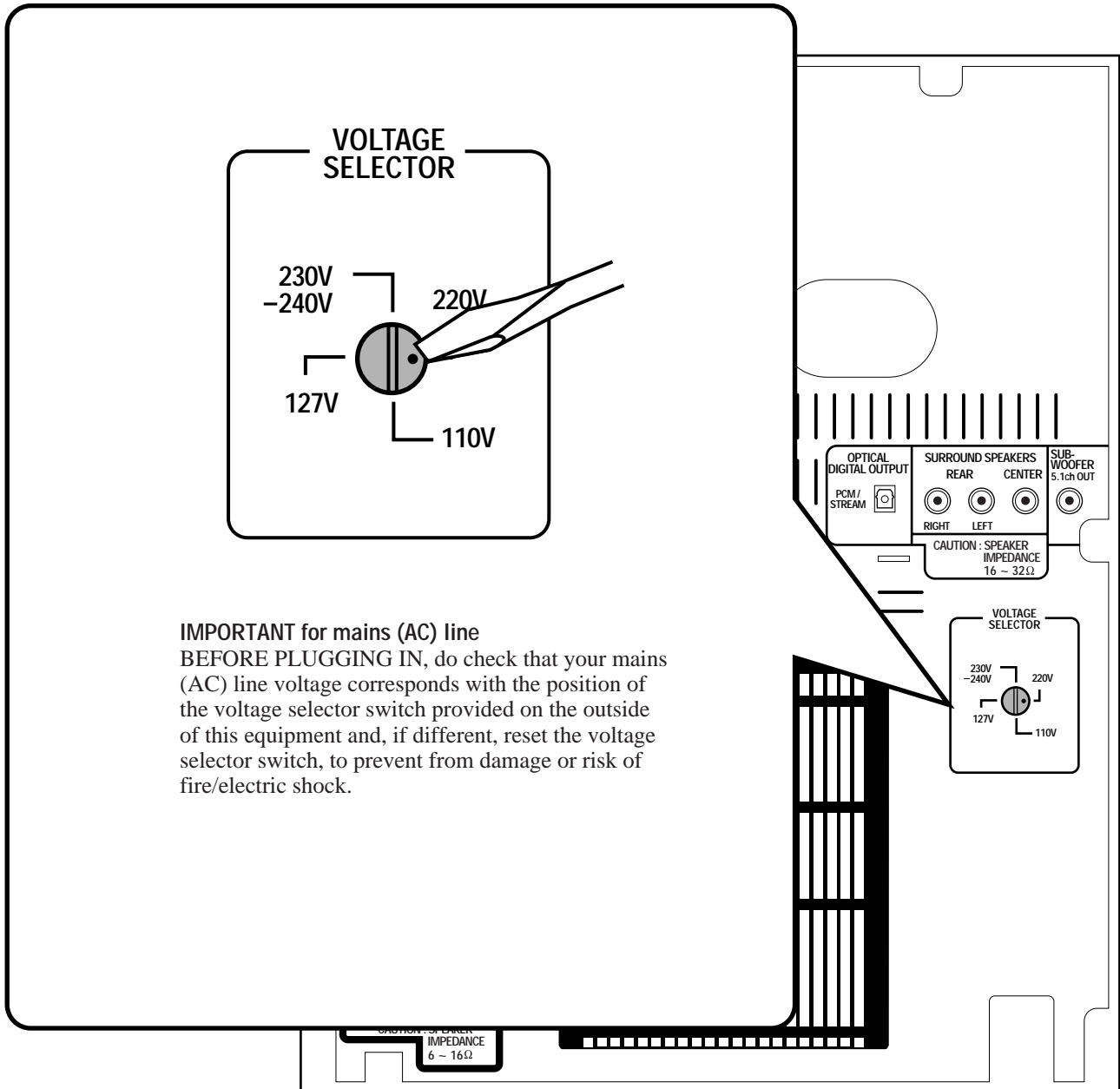

JVC
VICTOR COMPANY OF JAPAN, LIMITED

JVC INSTRUCTIONS

SPEAKER SYSTEM SP-MXDVA9

**MANUAL DE INSTRUCCIONES: SISTEMA DE
ALTAVOCES**
INSTRUÇÕES: SISTEMA DE ALTIFALANTES

說明書：揚聲器系統
دليل التعليمات: نظام السماعات

This system consists of the following systems:
Este sistema se compone de los cuatro siguientes:
Este equipamento compõe-se dos seguintes sistemas:

這一系統由下列系統組成：
يتكون هذا النظام من الأنظمة التالية:

FRONT SPEAKER SYSTEM : SP-MXG79
SISTEMA DE ALTAVOCES DELANTEROS : SP-MXG79
SISTEMA DE COLUNAS FRONTAIS : SP-MXG79

前置揚聲器系統：SP-MXG79
SP-MXG79 نظام السماعات الأمامية

CENTER SPEAKER SYSTEM : SP-DSC99TN
SURROUND SPEAKER SYSTEM : SP-DSS99TN
SISTEMA DE ALTAVOZ CENTRAL : SP-DSC99TN
SISTEMA DE ALTAVOCES PERIMÉTRICOS : SP-DSS99TN
SISTEMA DE COLUNA DE CENTRO : SP-DSC99TN
SISTEMA DE COLUNAS SURROUND : SP-DSS99TN

中置揚聲器系統：SP-DSC99TN
環繞揚聲器系統：SP-DSS99TN
SP-DSC99TN نظام السماعات الوسطى
SP-DSS99TN نظام سماعات صوت الإحاطة

— SAFETY INSTRUCTIONS — “SOME DOS AND DON'TS ON THE SAFE USE OF EQUIPMENT”

This equipment has been designed and manufactured to meet international safety standards but, like any electrical equipment, care must be taken if you are to obtain the best results and safety is to be assured.

Do read the operating instructions before you attempt to use the equipment.
Do ensure that all electrical connections (including the mains plug, extension leads and interconnections between pieces of equipment) are properly made and in accordance with the manufacturer's instructions. Switch off and withdraw the mains plug when making or changing connections.
Do consult your dealer if you are ever in doubt about the installation, operation or safety of your equipment.
Do be careful with glass panels or doors on equipment.

DON'T continue to operate the equipment if you are in any doubt about it working normally, or if it is damaged in any way — switch off, withdraw the mains plug and consult your dealer.
DON'T remove any fixed cover as this may expose dangerous voltages.
DON'T leave equipment switched on when it is unattended unless it is specifically stated that it is designed for unattended operation or has a standby mode.

Switch off using the switch on the equipment and make sure that your family know how to do this.
Special arrangements may need to be made for infirm or handi-capped people.
DON'T use equipment such as personal stereos or radios so that you are distracted from the requirements of traffic safety. It is illegal to watch television whilst driving.
DON'T listen to headphones at high volume as such use can permanently damage your hearing.
DON'T obstruct the ventilation of the equipment, for example with curtains or soft furnishing.
Overheating will cause damage and shorten the life of the equipment.
DON'T use makeshift stands and NEVER fix legs with wood screws — to ensure complete safety always fit the manufacturer's approved stand or legs with the fixings provided according to the instructions.
DON'T allow electrical equipment to be exposed to rain or moisture.
ABOVE ALL
— NEVER let anyone, especially children, push anything into holes, slots or any other opening in the case.
— this could result in a fatal electrical shock;
— NEVER guess or take chances with electrical equipment of any kind
— it is better to be safe than sorry!

Thank you for purchasing JVC speakers.

Before you begin using them, please read the instructions carefully to be sure you get the best possible performance. If you have any questions, consult your JVC dealer.

Le estamos muy agradecidos por haber adquirido estos altavoces de JVC.

Antes de utilizarlos, sírvase leer las instrucciones detenidamente a fin de obtener el mejor rendimiento posible. Si tiene alguna pregunta, acuda a su agente de JVC.

Gratos pela aquisição dos altifalantes JVC.

Antes de desfrutar este sistema, leia atentamente as instruções que o acompanham, de modo a assegurar-se da obtenção do melhor desempenho possível. Caso surjam dúvidas concernentes a este sistema, consulte o seu agente JVC.

感謝您惠購 JVC 揚聲器。

在開始使用之前，請您仔細閱讀本使用說明書，以確保您獲得揚聲器的最佳性能。如有疑問，請與 JVC 代理銷售商聯繫。

نشكرك على شراء سماعات جي في سي JVC.
قبل أن تبدأ استعمالها، يرجى قراءة هذه التعليمات بعناية حتى تتأكد من حصولك على أفضل أداء ممكن. إذا كان عندك أية أسئلة، عندها راجع موزع JVC لديك.

FRONT SPEAKER SYSTEM : SP-MXG79

FRONT SPEAKER SYSTEM : SP-MXG79

SISTEMA DE ALTAVOCES DELANTEROS : SP-MXG79

SISTEMA DE COLUNAS FRONTAIS : SP-MXG79

SPEAKER FOR A/V COMBINATION

SP-MXG79 have a magnetically-shielded design for placement adjacent to TV's and monitors without causing color aberrations. However, color may be affected as a result of how the speaker system is installed. Therefore, be careful of the following:

1. When placing these speakers near a TV set, turn off the TV's main power switch or unplug it before installing the speakers. Wait at least 30 minutes after the system is installed before turning on the TV's power.
2. If another speaker system has been set up near the TV set, that system may cause color unevenness in the TV's picture.
3. In spite of the shielded design of these speakers, some types of TV's may be affected by them. If this happens, move the speakers a short distance from the TV set.

ALTAVOZ PARA COMBINACIÓN A/V

El modelo SP-MXG79 tiene una construcción protegida magnéticamente para una colocación contigua de los televisores y monitores sin causar aberraciones de color.

Sin embargo, el color puede ser afectado como resultado del modo de instalar el sistema de altavoces.

1. Al colocar los altavoces cerca de un televisor, desactivar el interruptor de alimentación principal del televisor o desconectarlo antes de instalar los altavoces. Esperar a lo menos 30 minutos después de instalar el sistema y antes de activar la alimentación del televisor.
2. Si otro sistema del altavoz ha sido ajustado cerca del televisor, este sistema puede causar una desigualdad de color en la imagen del televisor.
3. A pesar de la protección de estos altavoces, algunos tipos de televisores pueden estar afectados por ellos. En este caso, mover los altavoces a una distancia corta de la unidad del televisor.

ALTIFALANTES PARA COMBINAÇÃO A/V

O SP-MXG79 tem uma estrutura blindada magneticamente para sua colocação perto de televisores e monitores sem causar anormalidades nas cores.

No entanto, as cores podem ser afectadas, dependendo de como o sistema de altifalantes for instalado. Tenha portanto cuidado com os seguintes pontos:

1. Ao colocar estes altifalantes perto de um televisor, desligue o interruptor de alimentação principal do televisor ou desligue-o da rede eléctrica antes de instalar os altifalantes. Espere pelo menos 30 minutos após a instalação do sistema antes de voltar a ligar o televisor.
2. Se houver um outro sistema de altifalantes instalado perto do televisor, tal sistema poderá causar irregularidade nas cores da imagem do televisor.
3. Apesar da estrutura blindada destes altifalantes, alguns tipos de televisores podem ser afectados por eles. Se isso acontecer, afaste os altifalantes um pouco do televisor.

前置揚聲器系統：SP-MXG79

SP-MXG79 نظام السماعات الأمامية

A/V 組合揚聲器

SP-MXG79 具有防磁設計，使之可鄰置於電視機和監視器旁而不會引起熒光屏色彩失常。然而，色彩將因揚聲器系統的安裝程序而受影響，因此請注意下列事項：

1. 當靠近電視機安置這些揚聲器時，在安裝之前先關斷電視機的主電源開關或拔出電源插頭。在整個系統被安裝好後，至少要等 30 分鐘後才可打開電視機的電源。
2. 如果其它的揚聲器系統已被置於電視機旁，則那個系統可能會引起電視機圖像的色彩不均勻。
3. 儘管這些揚聲器系統具有防磁設計，但有些電視機仍會受其影響。如果發生此現象，請將揚聲器系統移得離電視機稍微遠一些。

سماعة من أجل مجموعة الصوت A/V

تحتوي الوحدة SP-MXG79 على تصميم ذو حائل مغناطيسي من أجل الوضع بجوار أجهزة التلفزيون وأجهزة المراقبة بدون التسبب في انحراف الألوان. لكن قد تتأثر الألوان نتيجة طريقة تركيب نظام السماعة. لذلك، إحرص على التالي:

1. عند وضع تلك السماعات بجوار جهاز تلفزيون، إفضل مفتاح القدرة الرئيسي بجهاز التلفزيون أو إفضل قابسه قبل تركيب السماعات. إنتظر ٣٠ دقيقة على الأقل بعد تركيب النظام وقبل وصل قدرة جهاز التلفزيون.
2. إذا كان هناك نظام سماعة آخر موضوع بجوار جهاز التلفزيون، فقد يتسبب ذلك النظام في عدم انتظام الألوان في صورة جهاز التلفزيون.
3. على الرغم من التصميم ذو الحائل لتلك السماعات، فقد تتأثر بعض أنواع أجهزة التلفزيون بواسطتهم. إذا حدث ذلك، قم بتحريك السماعات مسافة قصيرة عن جهاز التلفزيون.

Connection

Conexión

Ligação

接線

التوصيل

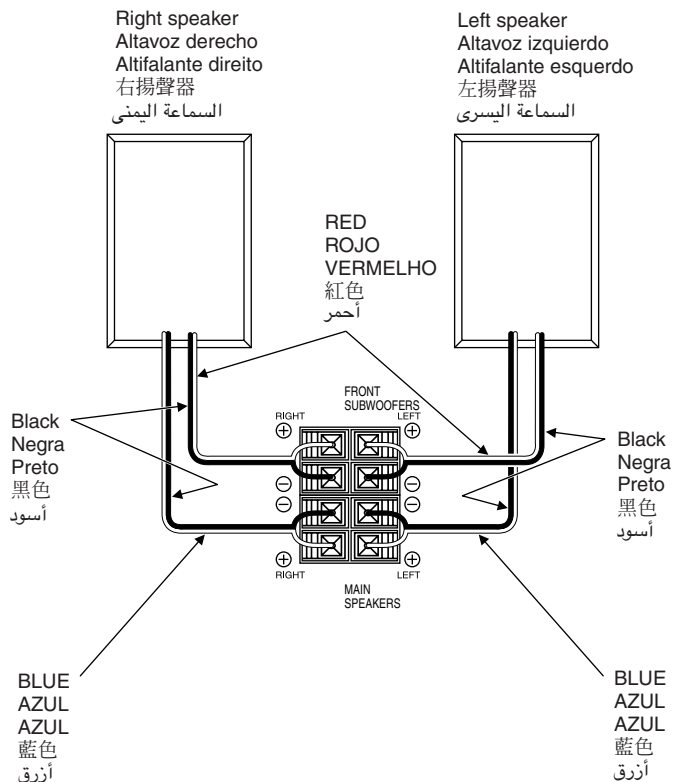

Amplifier output terminals
Terminales de salida de amplificador
Terminais de saída do amplificador
放大器輸出端子
نهايات خرج المضخم

CONNECTION

- DON'T use other amplifier to operate this speaker system except for CA-MXDVA9.
- Turn off power to the whole system before connecting the speakers to the amplifier.
- The maximum power handling capacity of the SP-MXG79 main speaker is 55 W/Front Subwoofer is 110 W. Excessive input will result in abnormal noise and possible damage. In cases where the signals described below are applied to the speakers, even if the signals are below the maximum allowable input, they may cause an overload and burn the wiring of the speakers. Be sure to lower the amplifier volume beforehand.
 - 1) Noise during FM tuning.
 - 2) High level signals containing high frequency components produced by a tape deck in the fast forward mode.
 - 3) Click noise produced when turning power of other components on and off.
 - 4) Click noise produced when connecting or disconnecting cords with the power on.
 - 5) Click noise produced when the cartridge is replaced with the power on.
 - 6) Click noise produced when operating amplifier switches.
 - 7) Continuous high frequency oscillation or high pitch electronically produced musical instrument sound.
 - 8) Howling when using a microphones.

SPECIFICATIONS

Type	: 3-way 3-speaker Bass-Reflex Type Twin Hyper Power-Drive Subwoofer (Magnetically-shielded type)
Speakers	
Front Subwoofer	: 14.0 cm (5-9/16 in.) cone × 1
Main woofer	: 16.0 cm (6-5/16 in.) cone × 1
Tweeter	: 5 cm (2 in.) cone × 1
Power Handling Capacity	
Front Subwoofer	: 110 W
Main Speaker	: 55 W
Impedance	
Front Subwoofer	: 6 Ω
Main Speaker	: 6 Ω
Frequency Range	
Front Subwoofer	: 29 Hz - 310 Hz
Main Speaker	: 70 Hz - 32 000 Hz
Sound Pressure Level	
Front Subwoofer	: 76 dB/W·m (Average of 50 Hz - 100 Hz)
Main Speaker	: 87 dB/W·m (Average of 400 Hz - 800 Hz)
Dimensions (W × H × D)	: 286 mm × 335 mm × 365 mm (11-5/16 in. × 13-1/4 in. × 14-3/8 in.)
Mass	: 6.3 kg (13.9 lbs) each

Design and specifications subject to change without notice.

CONEXIÓN

- NO utilice ningún otro amplificador para operar este sistema de altavoces excepto CA-MXDVA9.
- Desactive la alimentación de todo el sistema antes de conectar los altavoces al amplificador.
- La capacidad máxima de potencia del altavoz principal SP-MXG79 es de 55W, y del Subwoofer delantero es de 110W.

En casos donde las señales descritas más abajo se apliquen a los altavoces, aunque las mismas resulten menores que la entrada máxima permisible, pueden causar una sobrecarga y quemar el cableado de los altavoces. Asegúrese de disminuir el volumen del amplificador con anterioridad.

- 1) Ruido durante la sintonía en FM.
- 2) Señales de alto nivel que contengan componentes de alta frecuencia producidos por un magnetófono en el modo de avance rápido.
- 3) Ruidos de conmutación provocados al encender y apagar otros componentes.
- 4) Ruido de conmutación al conectar o desconectar cables con los componentes encendidos.
- 5) Ruido de conmutación cuando se reemplaza la cápsula con los componentes encendidos.
- 6) Ruido de conmutación provocados por la operación de los selectores del amplificador.
- 7) Continua oscilación de alta frecuencia o de sonidos de tonos altos provocados por instrumentos electrónicos.
- 8) Aullidos al utilizar micrófonos.

ESPECIFICACIONES

Tipo	: Reflex bajo con 3-altavoces y 3 vías Twin Hyper Power-Drive Subwoofers (Tipo de protección magnética)
Altavoces	
Subwoofer delantero	: Tipo cónico de 14,0 cm × 1
Principal	: Tipo cónico de 16,0 cm × 1
De agudos	: Tipo cónico de 5 cm × 1
Capacidad de potencia	
Subwoofer delantero	: 110 W
Principal	: 55 W
Impedancia	
Subwoofer delantero	: 6 Ω
Principal	: 6 Ω
Gama de frecuencias	
Subwoofer delantero	: 29 Hz—310 Hz
Principal	: 70 Hz—32 000 Hz
Nivel de presión acústica	
Subwoofer delantero	: 76 dB/W·m (Promedio de 50 Hz— 100 Hz)
Principal	: 87 dB/W·m (Promedio de 400 Hz—800 Hz)
Dimensiones (An × Al × Prf)	: 286 mm × 335 mm × 365 mm
Peso	: 6,3 kg cada uno

El diseño y las especificaciones están sujetos a cambio sin previo aviso.

LIGAÇÃO

- NÃO use outro amplificador para operar este sistema de altifalantes à exceção do CA-MXDVA9.
- Desligue a alimentação de todo o sistema antes de iniciar as ligações dos altifalantes ao amplificador.
- A máxima potência utilizável do altifalante principal do SP-MXG79 é de 55 W; a do subwoofer frontal é de 110 W.

Uma entrada excessiva resultará em ruídos anormais e possíveis avarias.

Nos casos em que os sinais descritos abaixo apresentem-se nos altifalantes, mesmo que os sinais estejam abaixo do nível de entrada permissível, poderão causar uma sobrecarga e o curto-circuito dos fios dos altifalantes. Certifique-se de reduzir o volume do amplificador de antemão.

- 1) Interferências durante a sintonia de FM.
- 2) Sinais com níveis elevados e com componentes de alta frequência produzidos pelo deck de cassetes durante o modo do avanço rápido.
- 3) Estalidos produzidos quando do ligar/desligar da alimentação de outros componentes.
- 4) Estalidos produzidos ao se ligar/desligar cabos de ligação com a alimentação ligada.
- 5) Estalidos produzidos quando da troca da célula fonocaptadora com a alimentação ligada.
- 6) Estalidos produzidos quando do activar/desactivar dos interruptores do amplificador.
- 7) Oscilação contínua das altas frequências ou altas tonalidades electronicamente produzidas por sons de músicas instrumentais.
- 8) Efeito de realimentação acústica (microfonia) quando da utilização de microfone.

ESPECIFICAÇÕES

Tipo	: Reflector de graves de 3 vías e 3 altifalantes Twin Hyper Power-Drive Subwoofers (Tipo blindado magneticamente)
Altifalantes	
Subwoofer frontal	: Cónico de 14,0 cm × 1
Woofers principal	: Cónico de 16,0 cm × 1
Tweeter	: Cónico de 5 cm × 1
Potência efectiva	
Subwoofer frontal	: 110 W
Altifalante principal	: 55 W
Impedância	
Subwoofer frontal	: 6 Ω
Altifalante principal	: 6 Ω
Amplitude de frequência	
Subwoofer frontal	: 29 Hz—310 Hz
Altifalante principal	: 70 Hz—32 000 Hz
Nível da pressão sonora	
Subwoofer frontal	: 76 dB/W·m (Média de 50 Hz—100 Hz)
Altifalante principal	: 87 dB/W·m (Média de 400 Hz—800 Hz)
Dimensões (larg. × alt. × prof.)	: 286 mm × 335 mm × 365 mm
Peso	: 6,3 kg cada

Desenho e especificações sob reserva de alterações sem aviso prévio.

التوصيل

接線

- 請勿使用其他放大器操作 CA-MXDVA9 以外的揚聲器系統。
- 要將揚聲器連接到放大器時，須關掉全裝置系統的電源。
- SP-MXG79 主揚聲器的最大功率儲備容量為 55 W (瓦)，前置副低音喇叭的為 110 W (瓦)。過大的輸入，將造成異常噪聲，甚至損壞揚聲器。當下列信號輸入揚聲器時，即使該信號低於最大容許輸入，仍有可能造成過載而燒毀揚聲器導線，故請預先調低放大器的音量控制，以籍安全。
 - 1) 在 FM 調諧中產生的噪聲。
 - 2) 磁帶錄音機的快進模式中產生的含有高頻成分的高電平信號。
 - 3) 開關其它組成部分電源時產生的卡嗒噪聲。
 - 4) 接通著電源進行接線或斷線時產生的喀嗒噪聲。
 - 5) 接通著電源更換卡盤時產生的喀嗒噪聲。
 - 6) 操作放大器開關時產生的喀嗒噪聲。
 - 7) 連續的高頻率振蕩或高音調電子裝置產生的樂器聲。
 - 8) 使用麥克風時發生的嘯聲。

- لا تستعمل مضخم صوت آخر لتشغيل نظام السماعات هذا باستثناء للموديل CA-MXDVA9.
- افضل الطاقة لكل النظام قبل توصيل السماعات بالمضخم.
- سعة التحمل القصوى للطاقة للسماعة الرئيسية للموديل SP-MXG79 هو 55 وات، مجهر الترددات الخفيضة الامامي هو 110 وات. الدخل الزائد سيؤدي الى تشويش شاذ وامكانية حدوث تلف.
- في الحالات التي تنطبق فيها الاشارات الموصوفة أدناه على السماعات، حتى لو كانت الاشارات دون أقصى دخل مسموح به، فانها قد تسبب حملاً زائداً وحرق اسلاك السماعات. لهذا تأكد من تخفيض جهارة صوت المضخم مقدماً.
- (1) تشويش أثناء موافقة البث FM.
- (2) اشارات ذات مستوى مرتفع تحوي مركبات تردد عال ناتجة عن جهاز كاسيت في وضع التقديم السريع.
- (3) صوت طقطقة ينتج عند تشغيل وايقاف الطاقة على الاجهزة الاخرى.
- (4) صوت طقطقة ينتج عند وصل أو فصل الاسلاك بينما تكون الطاقة موصلة.
- (5) صوت طقطقة ينتج عند استقبال الكارتريج بينما تكون الطاقة موصلة.
- (6) صوت طقطقة ينتج عند تشغيل مفاتيح المضخم.
- (7) ذبذبة مستمرة ذات تردد مرتفع أو نغمة عالية ناتجة الكترونياً عن صوت آلة موسيقية.
- (8) زعيق عند استخدام ميكروفون.

規格

類型 : 3 通道 3 揚聲器低音反射型
Twin Hyper Power-Drive
Subwoofers
(磁屏蔽型)

揚聲器

前置副低音喇叭 : 錐形紙盆 14.0 cm × 1
主喇叭 : 錐形紙盆 16.0 cm × 1
高音喇叭 : 錐形紙盆 5 cm × 1

最大功率

前置副低音喇叭 : 110 W (瓦)
主揚聲器 : 55 W (瓦)

阻抗

前置副低音喇叭 : 6 Ω (歐姆)
主揚聲器 : 6 Ω (歐姆)

頻率範圍

前置副低音喇叭 : 29 Hz — 3 10 Hz
主揚聲器 : 70 Hz — 32 000 Hz

聲壓級

前置副低音喇叭 : 76 dB/W · m (平均 50Hz~100Hz)
主揚聲器 : 87 dB/W · m (平均 400Hz~800Hz)

尺寸 (寬 × 高 × 深) : 286 mm × 335 mm × 365 mm

質量 : 每個 6.3 kg

設計與規格如有變更，恕不另行通知。

المواصفات

النوع : ثلاثي التكوين 3 سماعات من النوع العاكس
Twin Hyper Power-Drive
Subwoofers
(نوع واقعي مغناطيسي)

السماعة:

مجهر الترددات الخفيضة الامامي : نوع مخروطي 14.0 سم × 1
المجهر الرئيسي للترددات المنخفضة : نوع مخروطي 16.0 سم × 1
مجهر الترددات العالية : نوع مخروطي 5.0 سم × 1
سعة تشغيل القدرة:

مجهر الترددات الخفيضة الامامي : 110 واط
السماعة الرئيسية : 55 واط

المقاومة:

مجهر الترددات الخفيضة الامامي : 6 أوم
السماعة الرئيسية : 6 أوم

مجال الترددات:

مجهر الترددات الخفيضة الامامي : 29 - 310 هرتز
السماعة الرئيسية : 70 - 32000 هرتز

مستوى ضغط الصوت:

مجهر الترددات الخفيضة الامامي : 76 ديسيبل/واط-متر (متوسط 50 هرتز)
السماعة الرئيسية : 87 ديسيبل/واط-متر (متوسط 400 هرتز)

السماعة الرئيسية : 87 ديسيبل/واط-متر (متوسط 400 هرتز)
السماعة الرئيسية : 87 ديسيبل/واط-متر (متوسط 400 هرتز)

الابعاد : 286 مم × 335 مم × 365 مم
الوزن : 6.3 كجم لكل وحدة

التصميم والمواصفات عرضة للتغيير دون إشعار.

CENTER & SURROUND SPEAKER SYSTEM

CENTER SPEAKER SYSTEM : SP-DSC99TN
SURROUND SPEAKER SYSTEM : SP-DSS99TN

SISTEMA DE ALTAVOZ CENTRAL : SP-DSC99TN
SISTEMA DE ALTAVOCES PERIMÉTRICOS : SP-DSS99TN

SISTEMA DE COLUNA DE CENTRO : SP-DSC99TN
SISTEMA DE COLUNAS SURROUND : SP-DSS99TN

SPEAKER FOR A/V COMBINATION

SP-DSC99TN have a magnetically-shielded design for placement adjacent to TVs and monitors without causing color aberrations. However, color may be affected as a result of how the speaker system is installed. Therefore, be careful of the following:

1. When placing these speakers near a TV set, turn off the TV's main power switch or unplug it before installing the speakers.
Wait at least 30 minutes after the system is installed before turning on the TV's power.
2. If another speaker system has been set up near the TV set, that system may cause color unevenness in the TV's picture.
3. In spite of the shielded design of these speakers, some types of TV's may be affected by them. If this happens, move the speakers a short distance from the TV set.

HOW TO INSTALL SURROUND SPEAKERS

- This equipment is not magnet-proof. If it is placed near a TV set, color on a TV screen may become uneven. If the case of installation, therefore, locate it at sufficient distance from the TV set.
- The speakers of this system are designed to stand on the side or on the bottom, whichever you prefer.
- When setting the speaker on such as a high shelf, be sure to fix them to the shelf by using such as metal braces: this a precaution against the speakers falling off due to shelf trembling.

CAUTION: Attaching the speakers on the wall

The speakers are designed to be attached on the wall. When attaching them on the wall, have them attached to the wall by a qualified person.

DO NOT hang the speakers by yourself to avoid an unexpected danger of their falling from the wall, caused by incorrect attachment or weakness in the wall.

ALTAVOZ PARA COMBINACION A/V

El modelo SP-DSC99TN tiene una construcción protegida magnéticamente para una colocación contigua de los televisores y monitores sin causar aberraciones de color. Sin embargo, el color puede ser afectado como resultado del modo de instalar el sistema de altavoces.

1. Al colocar los altavoces cerca de un televisor, desactivar el interruptor de alimentación principal del televisor o desconectado antes de instalar los altavoces.
Esperar a lo menos 30 minutos después de instalar el sistema y antes de activar la alimentación del televisor.
2. Si otro sistema del altavoz ha sido ajustado cerca del televisor, este sistema puede causar una desigualdad de color en la imagen del televisor.
3. A pesar de la protección de estos altavoces, algunos tipos del televisores pueden estar afectados por ellos. En este caso, mover los altavoces a una distancia corta de la unidad del televisor.

COMO INSTALAR LOS ALTAVOCES DE ENTORNO

- Este equipo no tiene protección antimagnética. Si se lo coloca junto a un televisor, los colores en la pantalla pueden verse afectados. Si se da este caso, ubicar el equipo a más distancia del televisor.
- Los altoparlantes de este sistema han sido diseñados de manera que puedan ser utilizados en posición vertical o bien en posición horizontal, según se prefiera.
- Al ubicar los altoparlantes en lugares altos tales como repisas es importante asegurarnos correctamente con trabas para evitar el riesgo que caigan al moverse la repisa.

PRECAUCION: Instalación de los altavoces en la pared Los altavoces se han diseñado para fijarse a la pared. Cuando los instale en la pared, solicite a una persona calificada que lo haga por usted.

No cuelgue usted mismo los altavoces para evitar que puedan desprenderse debido a una instalación incorrecta o a la debilidad de la pared.

ALTIFALANTES PARA COMBINAÇÃO A/V

O SP-DSC99TN tem um desenho blindado magneticamente para sua colocação perto de televisores e monitores sem causar anormalidades nas cores.

No entanto, a color pode ser afectada dependendo de como o sistema de altifalantes for instalado.

Portanto, tome cuidado dos seguintes pontos:

1. Ao colocar estes altifalantes perto de um televisor, desligue o interruptor de alimentação principal do televisor ou desligue-o da rede eléctrica antes de instalar os altifalantes.
Espere pelo menos 30 minutos após a instalação do sistema antes de voltar a ligar o televisor.
2. Se houver um outro sistema de altifalantes instalado perto do televisor, tal sistema pode causar irregularidade nas cores na imagem do televisor.
3. Apesar do desenho blindado destes altifalantes, alguns tipos de televisores podem ser afectados por eles. Se isso acontecer, mova os altifalantes um pouco do televisor.

MANEIRA DE INSTALAR OS ALTIFALANTES DE SOM ENVOLVENTE

- O alto-falante não possui proteção anti-magnética, se este for colocado perto de um televisor, a cor da imagem poderá perder a nitidez. Por isso, quando da instalação, faça-a em um local relativamente distante do televisor.
- Os alto-falantes deste sistema são projetados para serem utilizados tanto na posição vertical como na horizontal, como você preferir.
- Ao instalar os alto-falantes em locais altos, como por exemplo, em cima de estantes, certifique-se de fixá-los bem à estante através de presilhas metálicas. Isso deve ser feito para prevenir que os alto-falantes não caiam, caso se mova a estante.

CUIDADO: Fixação dos altifalantes na parede

Os altifalantes foram concebidos para serem fixados na parede. Para a sua colocação, recorra a um técnico qualificado.

NÃO coloque os altifalantes por si mesmo para evitar riscos imprevistos de queda do material, por causa de uma fixação incorrecta ou fragilidade da parede.

中置揚聲器系統：SP-DSC99TN
環繞揚聲器系統：SP-DSS99TN

SP-DSC99TN نظام السماعات الوسطى

SP-DSS99TN نظام سماعات صوت الإحاطة

A/V 組合揚聲器

SP-DSC99TN 具有防磁設計，使之可臨置於電視機和監視器旁而不會引起發光屏色彩失常。然而，色彩將因揚聲器系統的位置而受影響，所以請注意下列事項：

1. 當靠近電視機安置這些揚聲器時，在安裝之前先關斷電視機的主電源開關或拔出電源插頭。在整個系統被裝好後，至少等待 30 分鐘才可打開電視機的電源。
2. 如果其他的揚聲器系統已被置於電視機旁，則那個系統可能會引起電視機圖像的色彩不平衡。
3. 儘管這些揚聲器具有防磁設計，但有些電視機仍會受其影響。如果發生此現象，請稍微移動揚聲器系統離開電視機遠一些。

如何安裝環繞立體揚聲器

- 本機不屬於防磁性裝置。如果靠近電視機安裝本機，電視機熒光屏的色彩可能變得均勻。因此在安裝時，將本機安放在從電視機充分離開的地方。
- 本系統的揚聲器設計成爲可以選擇豎立或橫放的任意一種方式使用。
- 在架子上等高處安放揚聲器使用時，必須使用金屬拉條等來固定在架子上，這是防止揚聲器因架子搖動而掉落的注意事項。

注意：將揚聲器安裝到牆上

揚聲器是爲安裝到牆上而設計的。將其安裝到牆上時，應由專業人員進行安裝。

不要自己懸掛揚聲器，以免因安裝不當或牆壁不夠堅固使其從牆上掉落的意外危險。

سماعة من أجل مجموعة الصوت و الصورة A/V

تحتوي الوحدة SP-DSC99TN على تصميم ذو حائل مغناطيسي من أجل الوضع بجوار أجهزة التلفزيون و أجهزة المراقبة بدون التسبب في انحراف الألوان. لكن، قد تتأثر الألوان نتيجة طريقة تركيب نظام السماعة. لذلك، إحرص على التالي:

١. عند وضع تلك السماعات بجوار جهاز تلفزيون، إفضل مفتاح القدرة الرئيسي بجهاز التلفزيون أو أفضل قابسه قبل تركيب السماعات.
انتظر ٣٠ دقيقة على الأقل بعد تركيب النظام و قبل وصل قدرة جهاز التلفزيون.
٢. إذا كان هناك نظام سماعة آخر موضوع بجوار جهاز التلفزيون، فقد يتسبب ذلك النظام في عدم انتظام الألوان في صورة جهاز التلفزيون.
٣. على الرغم من التصميم ذو الحائل لتلك السماعات، فقد تتأثر بعض أنواع أجهزة التلفزيون بواسطتهم. إذا حدث ذلك، حرك السماعات مسافة قصيرة عن جهاز التلفزيون.

كيفية تركيب السماعات المحيطة

- هذه الوحدة ليست مصممة ضد المغناطيسية. إذا تم وضعها قرب جهاز تلفزيون يمكن لألوان الصورة على شاشة التلفزيون أن تصبح غير منتظمة. لذا قم بتركيبها على بعد كاف من جهاز التلفزيون.
- هذه السماعات مصممة للوقوف على جانبها أو على قاعها، حسب رغبتك.
- هذه السماعات مصممة للوقوف على شئى مثل رف مرتفع، تأكد من تثبيتها في الرف باستخدام أداة تثبيت مثل زوايا التثبيت المعدنية. وذلك تحسبا لاحتمال سقوط السماعات إذا اهتز الرف.

تنبيه: تركيب السماعات على الجدار

تم تصميم السماعات للتركيب على الجدار. عند تركيبها على الجدار، أترك هذا العمل للشخص المؤهل به.

لاتقم بعملية تعليق السماعات بنفسك لتفادي الخطر غير المتوقع من جراء سقوطها عن الجدار، وهو ناتج عن التركيب غير الصحيح أو عن ضعف الجدار.

Amplifier Connection
Conexión del amplificador
Ligação do amplificador
放大器連接
التوصيل السماعات بالمضخم

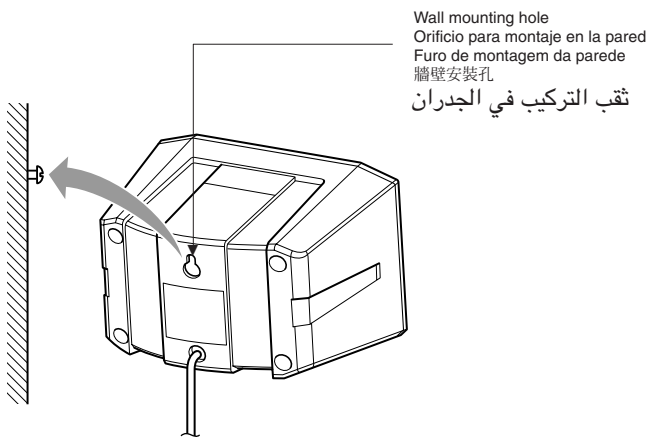
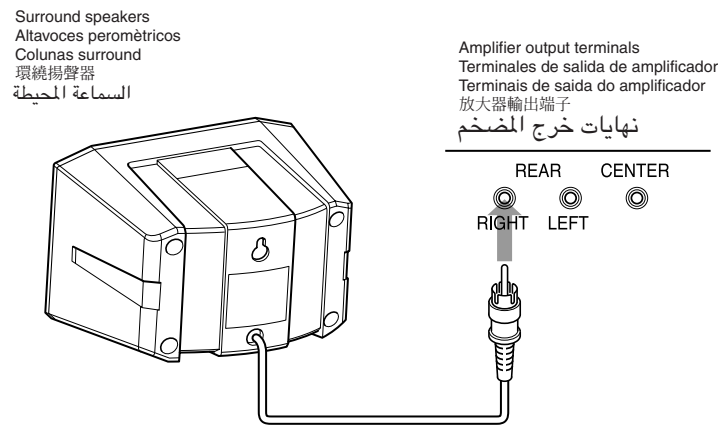
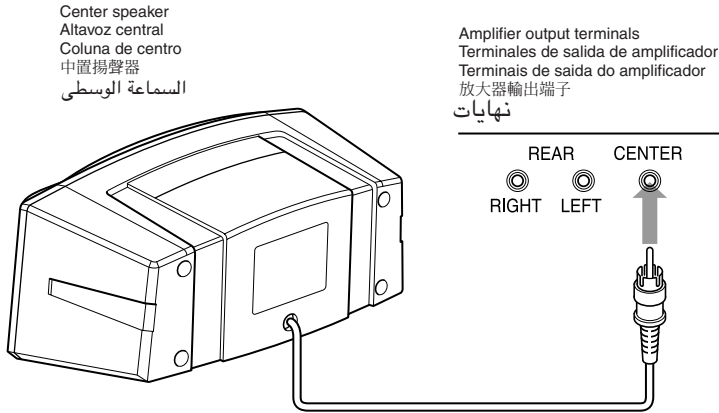

CONNECTION

A pin plug is attached to the tip of the speaker cord. If the speaker connection terminal on the amplifier to which the speaker is to be connected is a pin jack, connect the left-hand speaker's lead to the left terminal, and the right-hand speaker's lead to the right terminal.

- Turn off power of all equipment before connecting the speakers to the amplifier.
- The nominal impedance of the SP-DSC99TN is 16 ohms. Connect them to an amplifier with the load impedance of 16 ohms speaker.
- The nominal impedance of the SP-DSS99TN is 16 ohms. Connect them to an amplifier with the load impedance of 16 ohms speaker.
- The maximum power handling capacity is shown in the SPECIFICATIONS.

Excessive input to the speaker will result in abnormal noise and possible damage. The following cases described below may cause an overload of the speakers.

Be sure to lower the amplifier volume beforehand.

- 1) Noise during FM tuning.
- 2) High level signals containing high frequency components produced by a tape deck in the fast forward mode.
- 3) Click noise produced when turning power of other components on and off.
- 4) Click noise produced when connecting or disconnecting cords with the power on.
- 5) Click noise when the cartridge is replaced with the power on.
- 6) Click noise produced when operating amplifier switches.
- 7) Continuous high frequency oscillation or high pitch musical instrument sound.
- 8) Howling or feed back when using a microphones.

SPECIFICATIONS

SP-DSC99TN

Type	: Full range bass-reflex type (Magnetically-shielded type)
Speaker	
Full range	: 8 cm (3-3/16 in.) cone × 1
Power Handling Capacity	: 30 W
Impedance	: 16 Ω
Frequency Range	: 70 Hz – 25 000 Hz
Sound Pressure Level	: 84 dB/W·m
Dimensions (W × H × D)	: 245 mm × 110 mm × 145 mm (9-11/16 in. × 4-3/8 in. × 5-3/4 in.)
Mass	: 0.8 kg (1.8 lbs)

SP-DSS99TN

Type	: Full range bass-reflex type
Speaker	
Full range	: 8 cm (3-3/16 in.) cone × 1
Power Handling Capacity	: 30 W
Impedance	: 16 Ω
Frequency Range	: 85 Hz – 20 000 Hz
Sound Pressure Level	: 83 dB/W·m
Dimensions (W × H × D)	: 160 mm × 110 mm × 136 mm (6-5/16 in. × 4-3/8 in. × 5-3/8 in.)
Mass	: 0.55 kg (1.3 lbs)

Design and specifications subject to change without notice.

CONEXIÓN

Una clavija monopolar está fijada al extremo del cordón del altavoz. Si el terminal de conexión para altavoz en el amplificador al cual se conectará el altavoz es un jack monopolar, conecte el cable del altavoz izquierdo al terminal izquierdo, y el cable de altavoz derecho al terminal derecho.

- Desactivar la alimentación de todo el equipo antes de conectar el altoparlante al amplificador.
- La impedancia nominal des SP-DSC99TN es de 16 ohmios. Conecte los altavoces a un amplificador con una impedancia de carga de 16 ohmios.
- La impedancia nominal des SP-DSS99TN es de 16 ohmios. Conecte los altavoces a un amplificador con una impedancia de carga de 16 ohmios.
- La capacidad de uso de la alimentación máxima se indica en la sección de las ESPECIFICACIONES.

Una entrada excesiva del altavoz causará ruido anormal y posibilidad de daño. Los casos descritos a continuación pueden ocasionar una sobrecarga de los altavoces. Asegúrese de que el volumen del amplificador sea reducido de antemano.

- 1) Ruido durante la sintonía en FM.
- 2) Señales de alto nivel que contengan componentes de alta frecuencia producidos por un magnetófono en el modo de avance rápido.
- 3) Ruidos de conmutación provocados al encender y apagar otros componentes.
- 4) Ruido de conmutación al conectar o desconectar cables con los componentes encendidos.
- 5) Ruido de conmutación cuando se reemplaza la cápsula con los componentes encendidos.
- 6) Ruido de conmutación provocados por la operación de los selectores del amplificador.
- 7) Oscilación de frecuencia elevada continua o sonido de instrumento musical de tono elevado.
- 8) Zumbido o feed back cuando se utiliza un micrófono.

ESPECIFICACIONES

SP-DSC99TN

Tipo	: Tipo bajo reflex de gamma completa (Tipo de protección magnética)
Altavoz	
Gamma completa	: Tipo cónico de 8 cm × 1
Potencia máxima	: 30 W
Impedancia	: 16 Ω
Gamma de frecuencia	: 70 Hz – 25.000 Hz
Nivel de presión sonora	: 84 dB/W·m
Dimensiones (An × Al × Prf)	: 245 mm × 110 mm × 145 mm
Peso	: 0,8 kg

SP-DSS99TN

Tipo	: Tipo bajo reflex de gamma completa
Altavoz	
Gamma completa	: Tipo cónico de 8 cm × 1
Potencia máxima	: 30 W
Impedancia	: 16 Ω
Gamma de frecuencia	: 85 Hz – 20.000 Hz
Nivel de presión sonora	: 83 dB/W·m
Dimensiones (An × Al × Prf)	: 160 mm × 110 mm × 136 mm
Peso	: 0,55 kg

El diseño y las especificaciones están sujetos a cambios sin aviso.

LIGAÇÃO

O plugue do pino é colocado na ponta do fio do alto-falante. Se o terminal de conexão do alto-falante ao amplificador, onde esse alto-falante será conectado, é do tipo de "jack" de pinos, conecte o cabo do alto-falante esquerdo ao terminal esquerdo, e o cabo do alto-falante direito ao terminal direito.

- Desligue a alimentação de todo o equipamento antes de ligar os altifalantes ao amplificador.
- A impedância nominal dos SP-DSC99TN é de 16 ohm. Ligue-os a um amplificador com uma impedância de carga de 16 ohm por altifalante.
- A impedância nominal dos SP-DSS99TN é de 16 ohm. Ligue-os a um amplificador com uma impedância de carga de 16 ohm por altifalante.
- A capacidade máxima de potência é mostrada nas ESPECIFICAÇÕES.

Uma entrada excessiva para os altifalantes resultará em ruído anormal e possíveis danos aos mesmos. Os seguintes casos descritos abaixo podem causar uma sobrecarga dos altifalantes. Certifique-se de abaixar o volume do amplificador de antemão.

- 1) Interferências durante a sintonia FM.
- 2) Sinais com níveis elevados e com componentes de alta frequência produzidos pelo deck de cassetes durante o modo do avanço rápido.
- 3) Estalidos produzidos quando do ligar/desligar da alimentação de outros componentes.
- 4) Estalidos produzidos ao se ligar/desligar cabos de ligação com a alimentação ligada.
- 5) Estalidos produzidos quando da troca da célula fonocaptadora com a alimentação ligada.
- 6) Estalidos produzidos quando do activar/desactivar dos interruptores no amplificador.
- 7) Oscilação de alta frequência contínua ou som de instrumento musical de alto tom.
- 8) Uivo de áudio ou realimentação ao usar microfones.

ESPECIFICAÇÕES

SP-DSC99TN

Tipo	: Tipo de reflexlo de graves em gama completa (Tipo blindado magneticamente)
Altifalante	
Gama completa	: 8 cm cónico × 1
Potência efectiva	: 30 W
Impedância	: 16 Ω
Gama de frequência	: 70 Hz – 25.000 Hz
Nível de Pteslo Sonora	: 84 dB/W·m
Dimensões (L × A × P)	: 245 mm × 110 mm × 145 mm
Peso	: 0,8 kg

SP-DSS99TN

Tipo	: Tipo de reflexlo de graves em gama completa
Altifalante	
Gama completa	: 8 cm cónico × 1
Potência efectiva	: 30 W
Impedância	: 16 Ω
Gama de frequência	: 85 Hz – 20.000 Hz
Nível de Pteslo Sonora	: 83 dB/W·m
Dimensões (L × A × P)	: 160 mm × 110 mm × 136 mm
Peso	: 0,55 kg

Design e especificações sujeitos a alterações sem aviso prévio.

التوصيل

تم تثبيت قابس دبوسي في طرف سلك سماعة التكبير. إذا كان طرف توصيل السماعة في المضخم الذي تريد توصيل السماعة به من طراز القبس الدبوسي، قم بتوصيل سلك السماعة الأيسر بالطرف الأيسر والسلك الأيمن بالطرف الأيمن.

- حول القدرة لجميع الأجهزة إلى إيقاف قبل توصيل السماعات إلى المضخم.
- المعاوقة الأسمية للوحدة SP-DSC99TN تكون 8 أوم. وإصلها إلى توصيلات سماعة المضخم 8 أوم.
- المعاوقة الأسمية للوحدة SP-DSS99TN تكون 8 أوم. وإصلها إلى توصيلات سماعة المضخم 8 أوم.
- سعة تداول القدرة القصوى موضحة في المواصفات. سوف يسبب الإدخال المفرط للسماعة تشويش غير طبيعي و تلف محتمل. الحالات التالية الموصوفة بأسفله قد تتسبب في تحميل زائد للسماعات. تأكد من خفض جهارة صوت المضخم مسبقا.
 - (1) تشويش أثناء موافقة البث FM.
 - (2) اشارات ذات مستوى مرتفع تحوي مركبات تردد عال ناتجة عن جهاز كاسيت في وضع التقديم السريع.
 - (3) صوت طقطقة ينتج عند تشغيل وإيقاف الطاقة على الاجهزة الاخرى.
 - (4) صوت طقطقة ينتج عند وصل أو فصل الاسلاك بينما القدرة موصلة.
 - (5) صوت طقطقة ينتج عند استبدال الكارتريج بينما القدرة موصلة.
 - (6) صوت طقطقة ينتج عند تشغيل مفاتيح المضخم.
 - (7) استمرار تذبذب ذو تردد عال أو صوت اجهزة موسيقية ذات طبقة صوت عالية.
 - (8) الصياح أو التغذية المرتدة عند استخدام ميكروفونات.

توصيل

توصيل السماعة في المضخم الذي تريد توصيل السماعة به من طراز القبس الدبوسي، قم بتوصيل سلك السماعة الأيسر بالطرف الأيسر والسلك الأيمن بالطرف الأيمن.

- في توصيل السماعات إلى المضخم، تأكد من خفض جهارة صوت المضخم مسبقا.
- حول القدرة لجميع الأجهزة إلى إيقاف قبل توصيل السماعات إلى المضخم.
- المعاوقة الأسمية للوحدة SP-DSC99TN تكون 8 أوم. وإصلها إلى توصيلات سماعة المضخم 8 أوم.
- المعاوقة الأسمية للوحدة SP-DSS99TN تكون 8 أوم. وإصلها إلى توصيلات سماعة المضخم 8 أوم.
- سعة تداول القدرة القصوى موضحة في المواصفات. سوف يسبب الإدخال المفرط للسماعة تشويش غير طبيعي و تلف محتمل. الحالات التالية الموصوفة بأسفله قد تتسبب في تحميل زائد للسماعات. تأكد من خفض جهارة صوت المضخم مسبقا.

توصيل السماعة في المضخم الذي تريد توصيل السماعة به من طراز القبس الدبوسي، قم بتوصيل سلك السماعة الأيسر بالطرف الأيسر والسلك الأيمن بالطرف الأيمن.

- (1) تشويش أثناء موافقة البث FM.
- (2) اشارات ذات مستوى مرتفع تحوي مركبات تردد عال ناتجة عن جهاز كاسيت في وضع التقديم السريع.
- (3) صوت طقطقة ينتج عند تشغيل وإيقاف الطاقة على الاجهزة الاخرى.
- (4) صوت طقطقة ينتج عند وصل أو فصل الاسلاك بينما القدرة موصلة.
- (5) صوت طقطقة ينتج عند استبدال الكارتريج بينما القدرة موصلة.
- (6) صوت طقطقة ينتج عند تشغيل مفاتيح المضخم.
- (7) استمرار تذبذب ذو تردد عال أو صوت اجهزة موسيقية ذات طبقة صوت عالية.
- (8) الصياح أو التغذية المرتدة عند استخدام ميكروفونات.

المواصفات

SP-DSC99TN

النوع	: مجال كامل من نوع عاكس لنغمات التردد المنخفض (نوع ذو حائل مغناطيسي)
السماعة:	
المجال الكامل	: مخروط 8 سم × 1
سعة تداول القدرة	: 30 واط
المعاوقة	: 16 Ω (أوم)
مجال التردد	: 70Hz – 25,000Hz
مستوى ضغط الصوت	: 84dB/W.m
الأبعاد (عرض × ارتفاع × عمق)	: 245mm × 110mm × 145mm (9-11/16 × 4-3/8 × 5-3/4 英吋)
الوزن	: 0.8kg (1.8 磅)

SP-DSS99TN

النوع	: مجال كامل من نوع عاكس لنغمات التردد المنخفض
السماعة:	
المجال الكامل	: مخروط 8 سم × 1
سعة تداول القدرة	: 30 واط
المعاوقة	: 16 Ω (أوم)
مجال التردد	: 85Hz – 20,000Hz
مستوى ضغط الصوت	: 83dB/W.m
الأبعاد (عرض × ارتفاع × عمق)	: 160mm × 110mm × 136mm (6-5/16 × 4-3/8 × 5-3/8 英吋)
الوزن	: 0.55kg (1.3 磅)

التصميم والمواصفات عرضة للتغيير بدون إشعار

التصميم والمواصفات عرضة للتغيير بدون إشعار

التصميم والمواصفات عرضة للتغيير بدون إشعار

التصميم والمواصفات عرضة للتغيير بدون إشعار

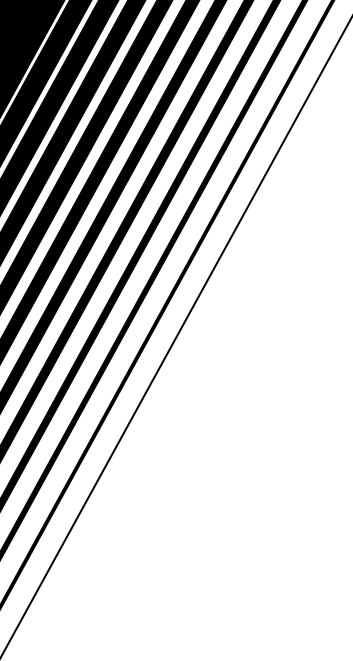

JVC
VICTOR COMPANY OF JAPAN, LIMITED

NOTICE

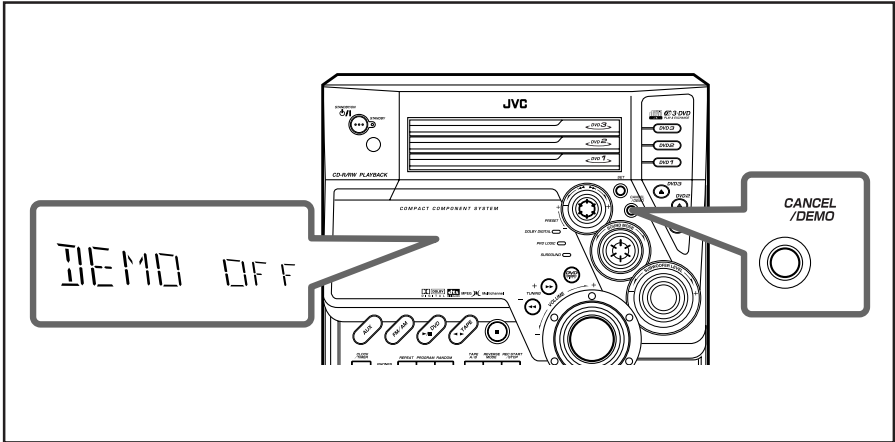

Display Demonstration

When connecting the AC power cord into a wall outlet, the unit automatically starts display demonstration.

To cancel the display demonstration, press CANCEL/DEMO until “DEMO OFF” appears on the display.

- For more detailed information about demonstration, see page 10.